

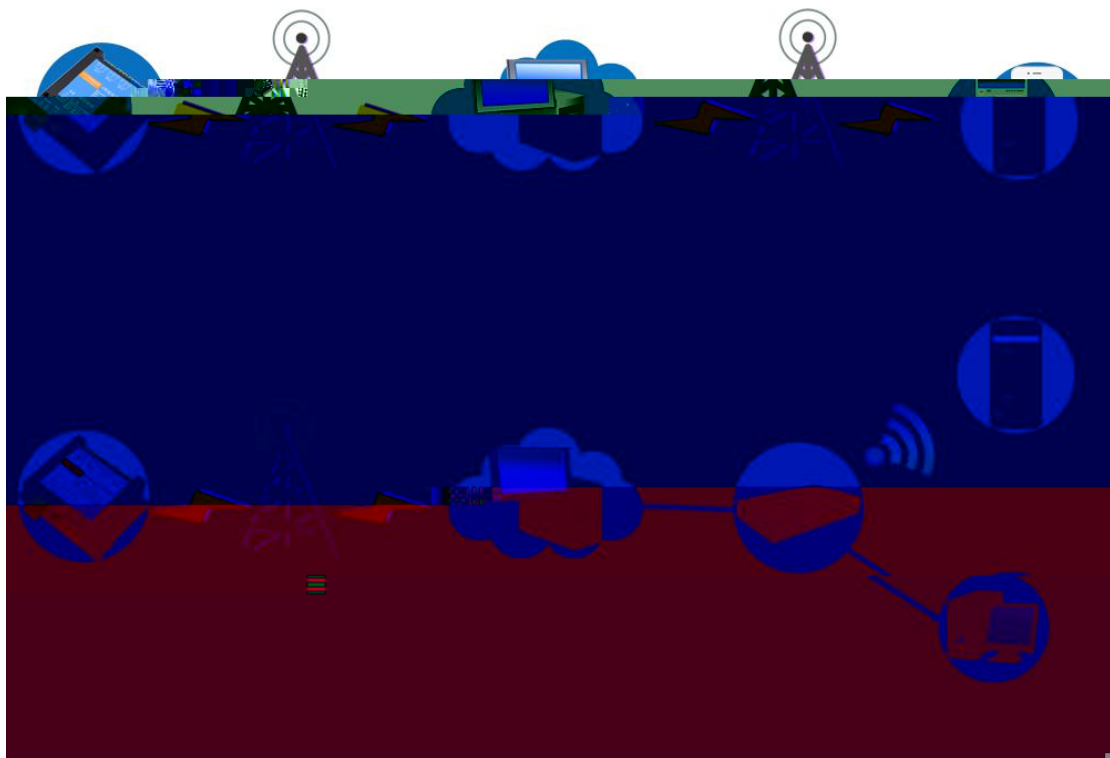

-
-
-
-
-

-
-
-
-

一、使用移动网络



④①	③⑨	③⑧	③⑦	③⑥	③⑤	③④	③③	③②	③①	③①	②⑨	②⑧	②⑦	②⑥	②⑤	②④	②③	②②	②①
VD+	VD-	CH1	CH2	CH3	CH4	CH5	CH6	CH7	CH8	CH9	CH10	CH11	CH12	CH13	CH14	CH15	CH16	CH17	CH18

JY-DAM2010
 JUYING ELECTRONIC

DAM2010数据采集器

- 供电电压: DC 7-30V
- 输出: 250V 10A触点
- 通信协议: MODBUS RTU
- 通信端口:

■ RS232	■ RS485	■ RF
■ 网口	■ WIFI	■ USB

电源		RS485			RS232														
+	-	A+	B-	PB	TX	RX	AD1	AD2	AD3	AD4	AD5	AD6	AD7	AD8	AD9	AD10	COM	CH20	CH19
①	②	③	④	⑤	⑥	⑦	⑧	⑨	⑩	⑪	⑫	⑬	⑭	⑮	⑯	⑰	⑱	⑲	⑳

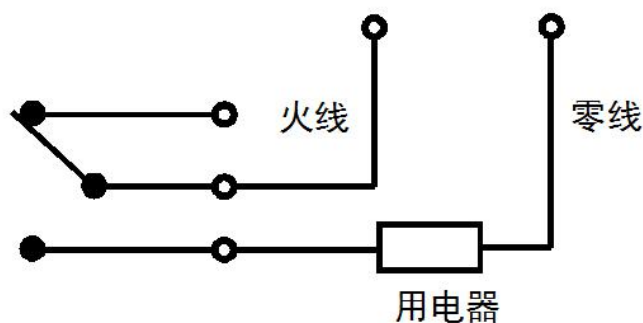

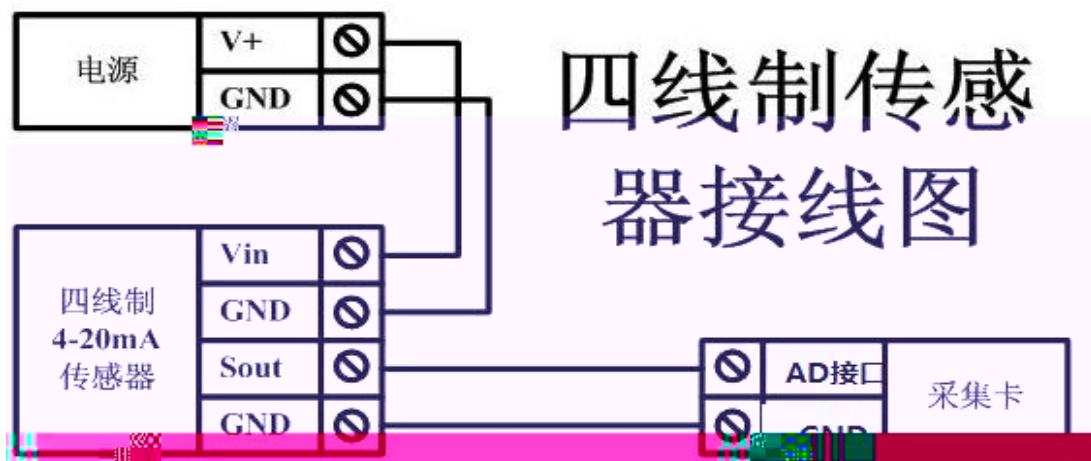
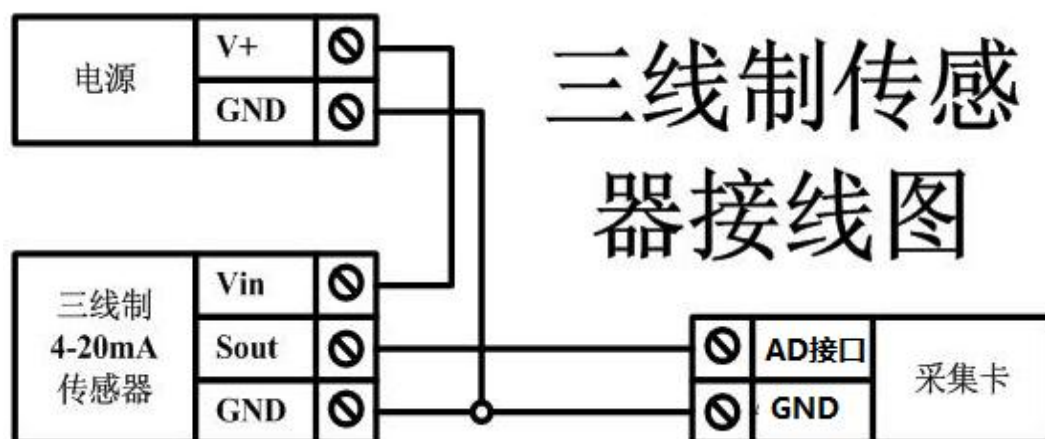
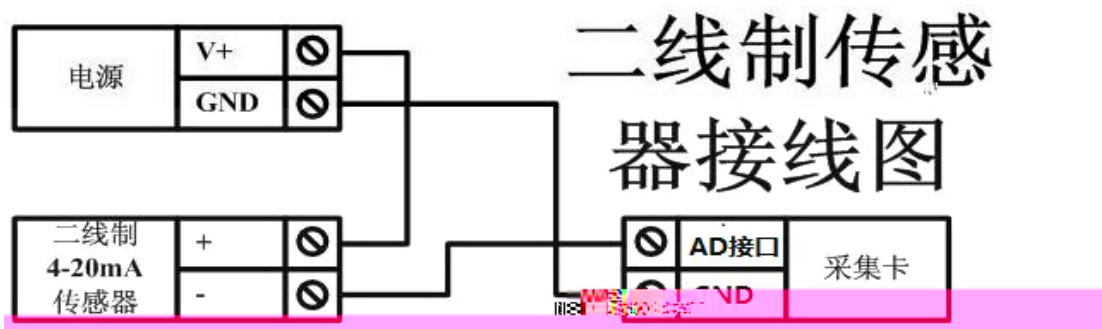



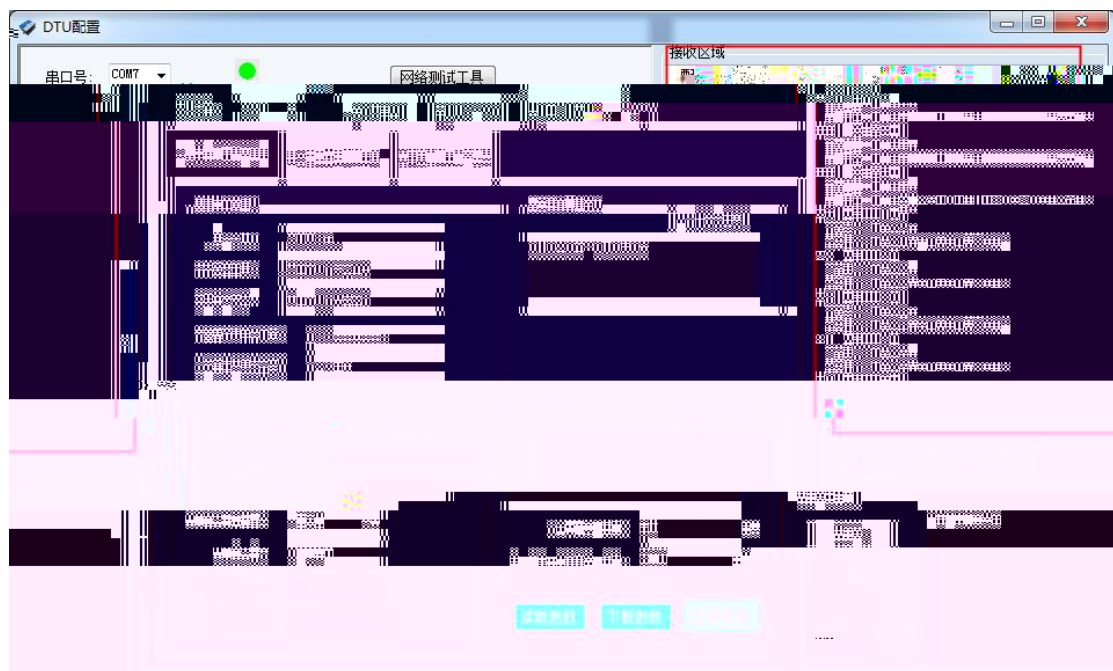



新增设备

产品型号

用户名称 请输入设备别名

fUNID

15:17 0.76K/s 4G 68%

新增设备

产品型号

用户名称

fUNID

dam0404

dam0808

RTU6660

PT04

dam0606

dam0800

DAM1600A

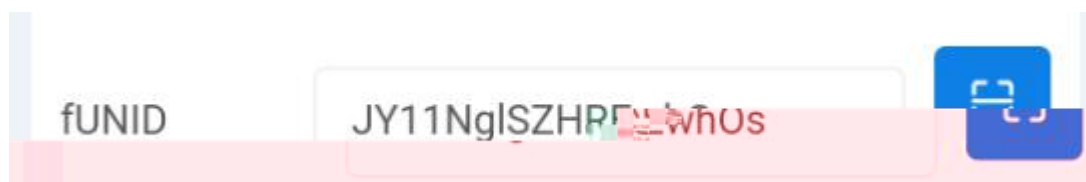
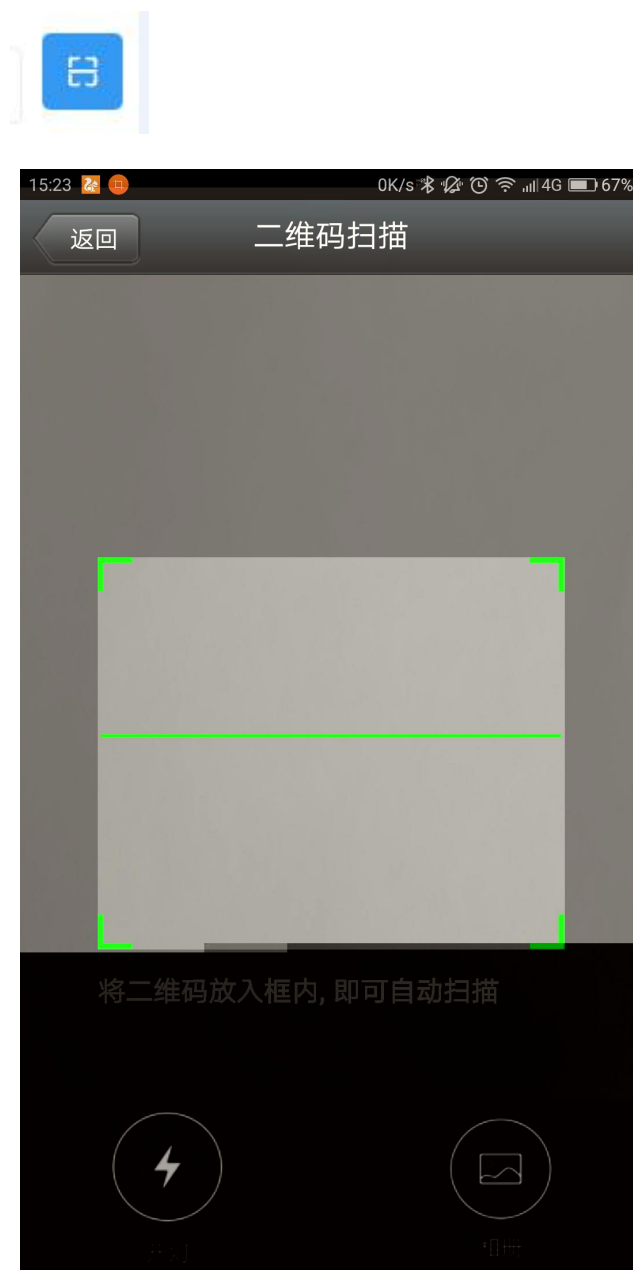

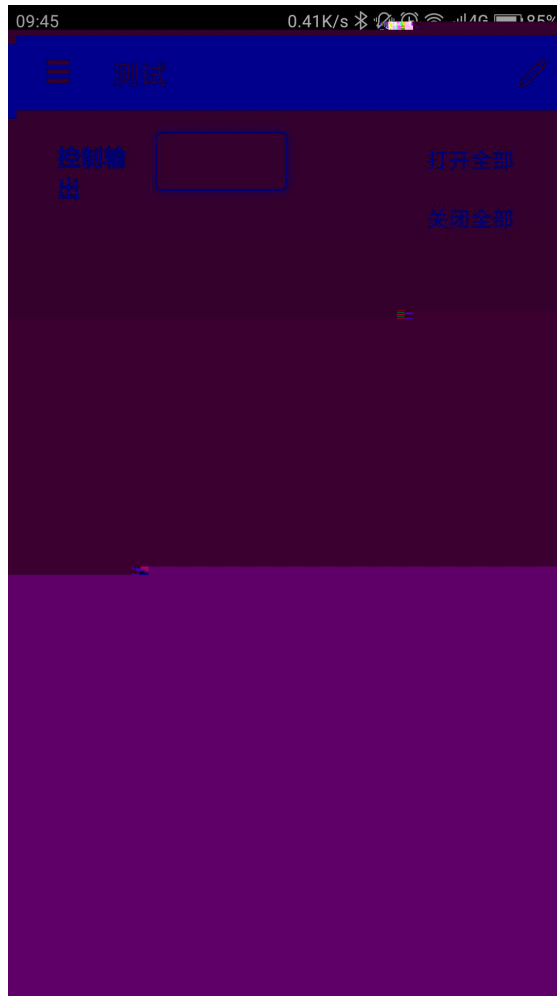



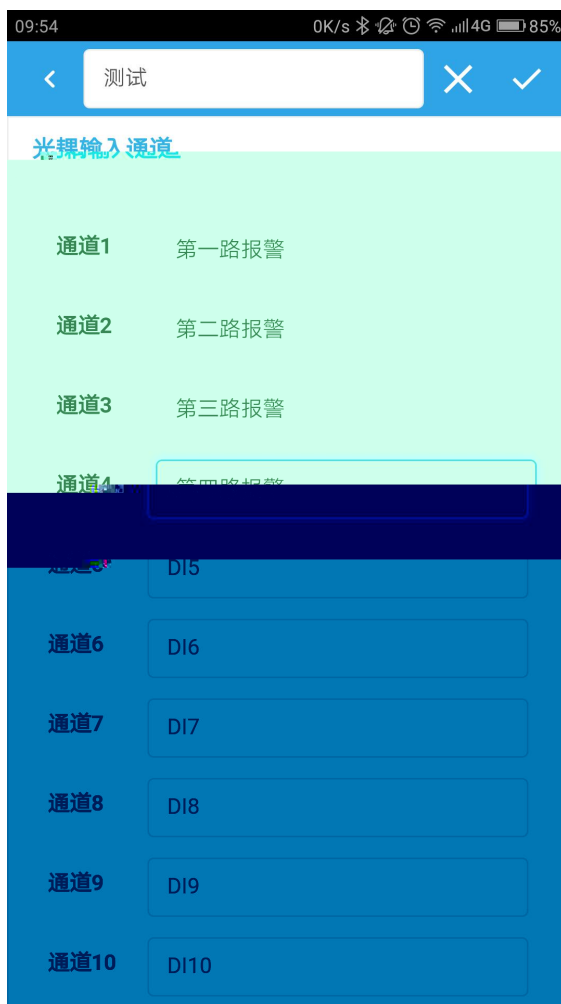

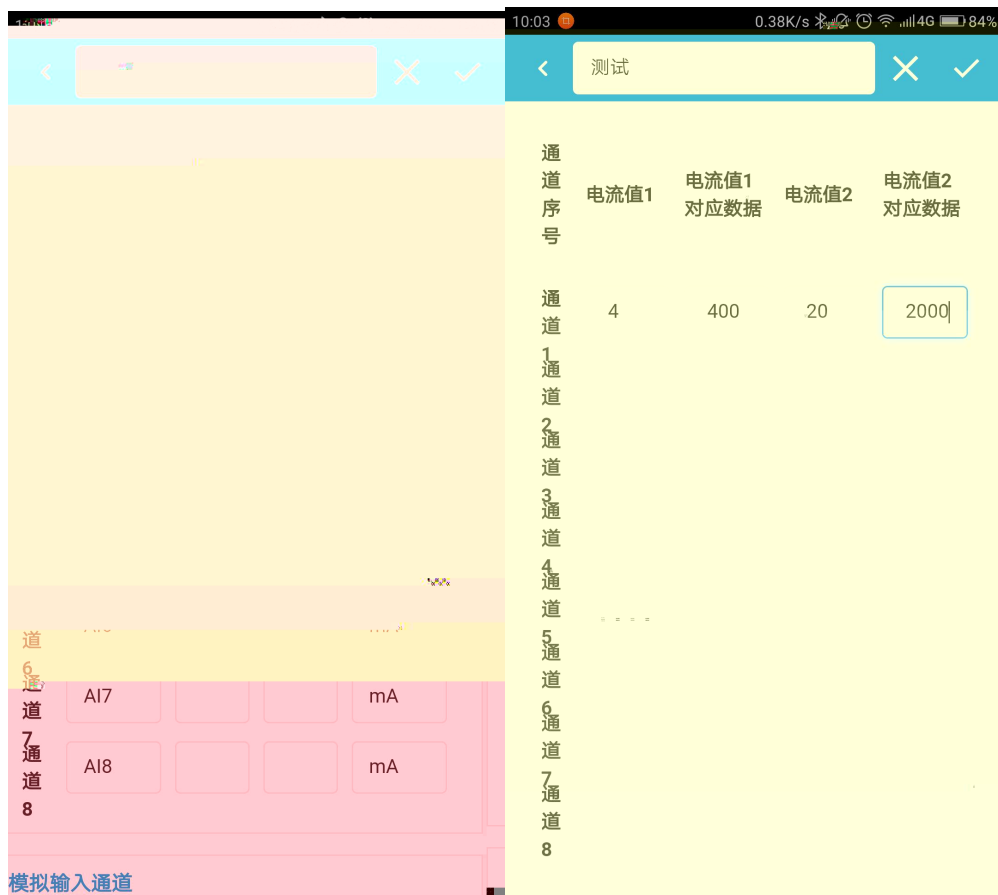

通道序号

通道

电流值1	电流值1 对应数据	电流值2	电流值2 对应数据
4000	0	20000	100

