

DAM1012D-GPRS

V1.0



-
-
-
-
-

-
-
-
-

	modbus	RS232	RS485	USB	GSM	
DAM012-GPRS						10

	<pre> %\$5# \$J87 %\$5#&) \$J57 %\$; GA 87 +! (\$J % @98 %\$ @98 !(\$,) </pre>
--	---

	%) t - (t (% a a
	' ' \$ [
	- * \$ \$ b ž , ž %
	& (\$ \$ ž (, \$ \$ ž - * \$ \$ ž % & \$ \$ ž ' , (\$ \$
	U d d
	@ V j] Y k X

一、使用移动网络

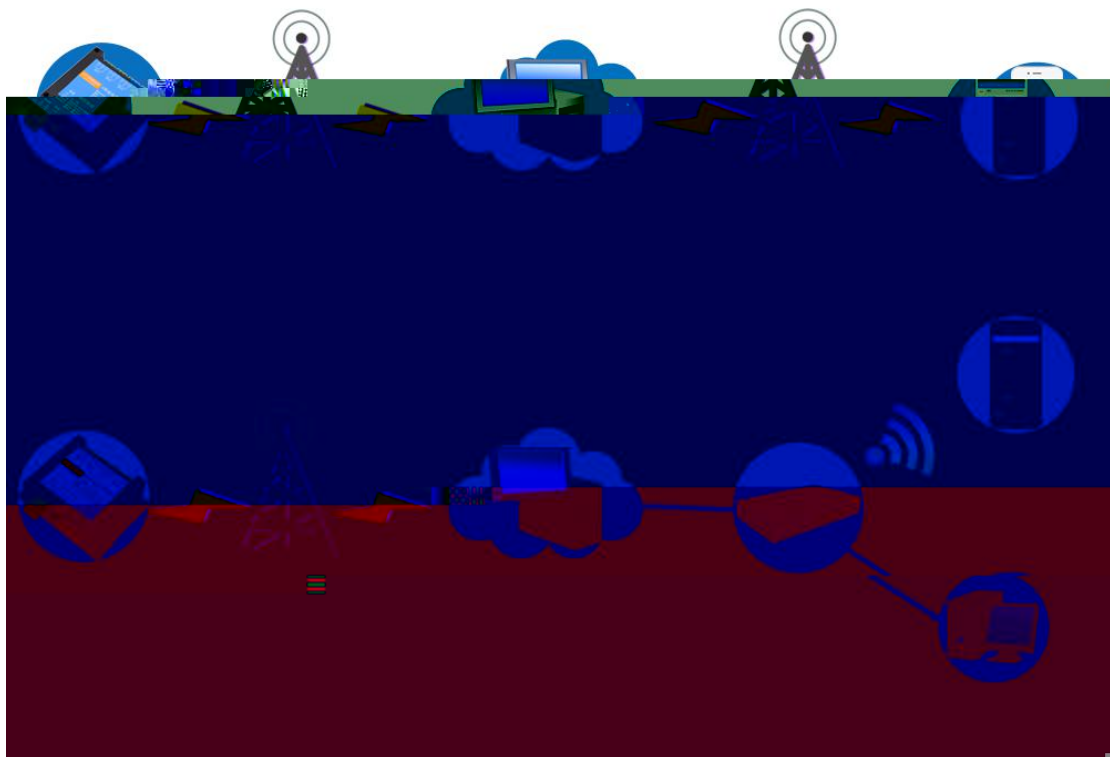

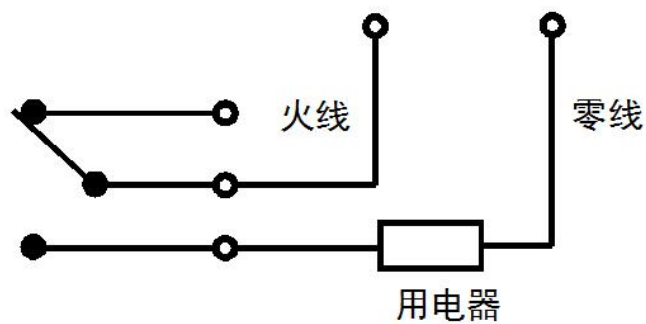
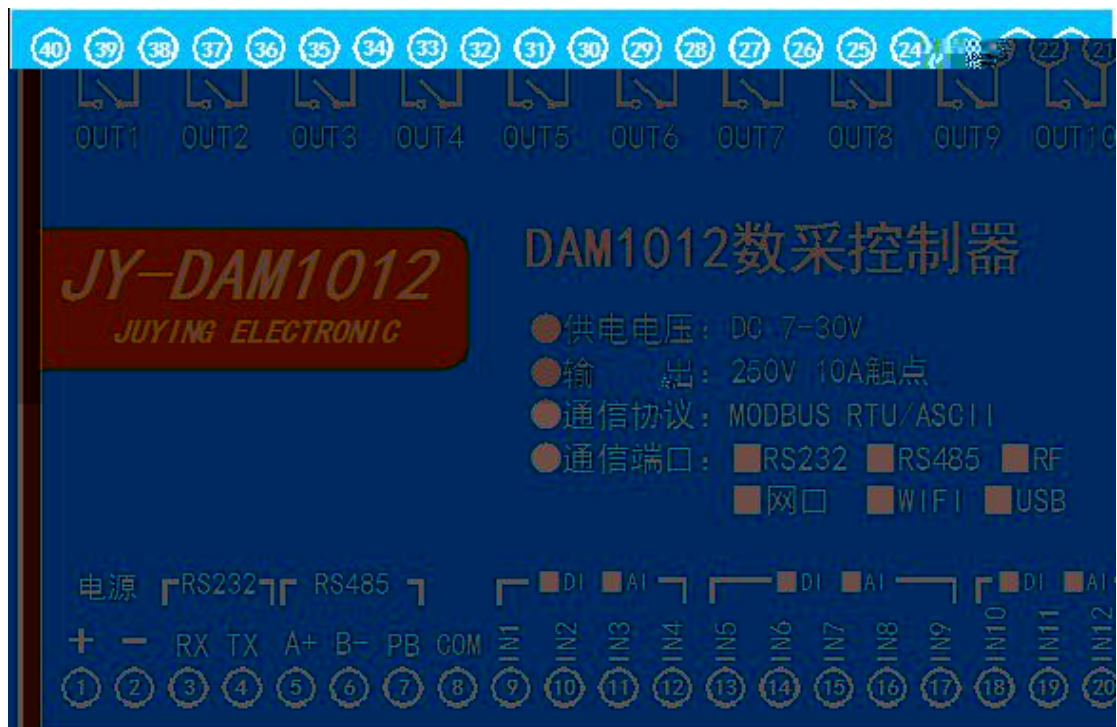

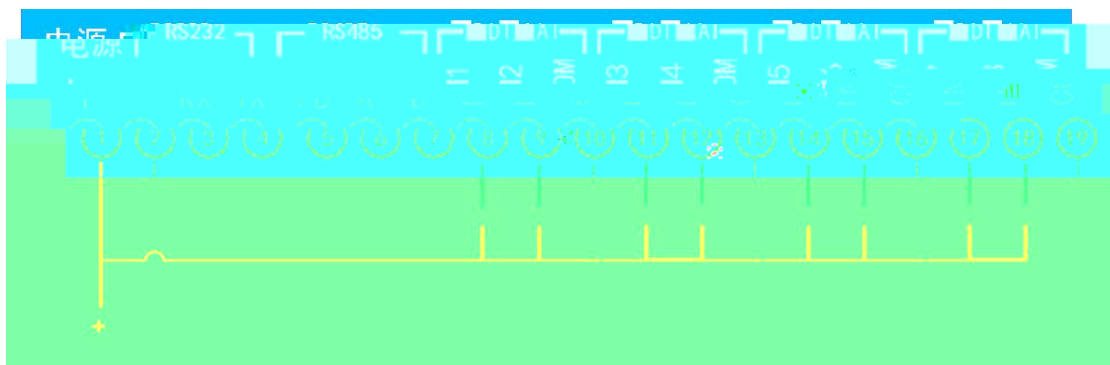
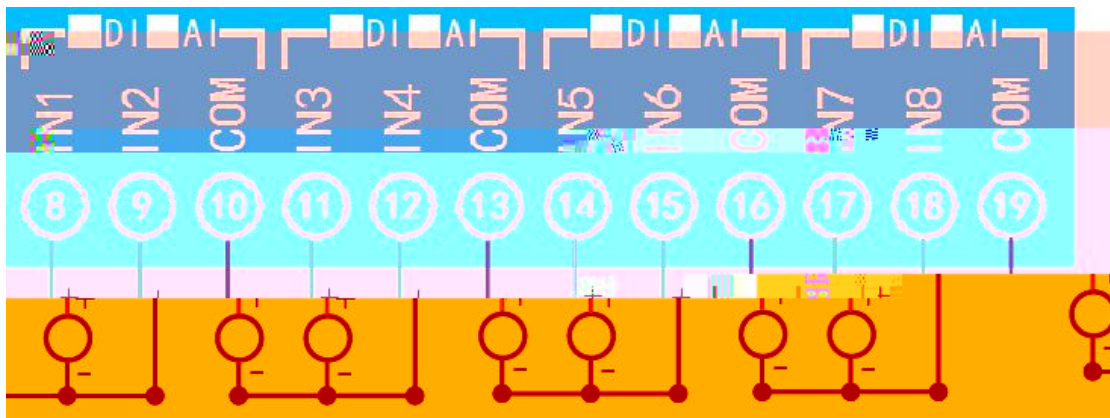







“ ”

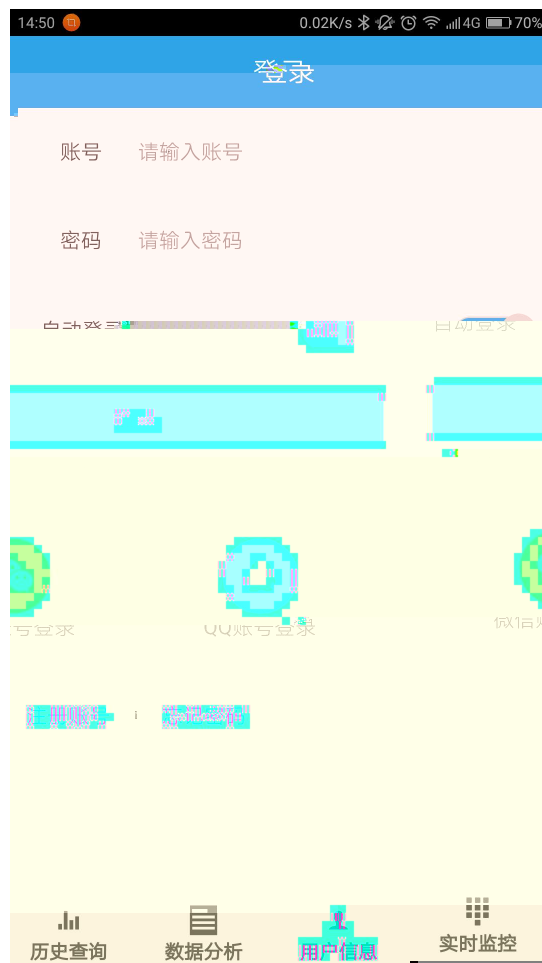

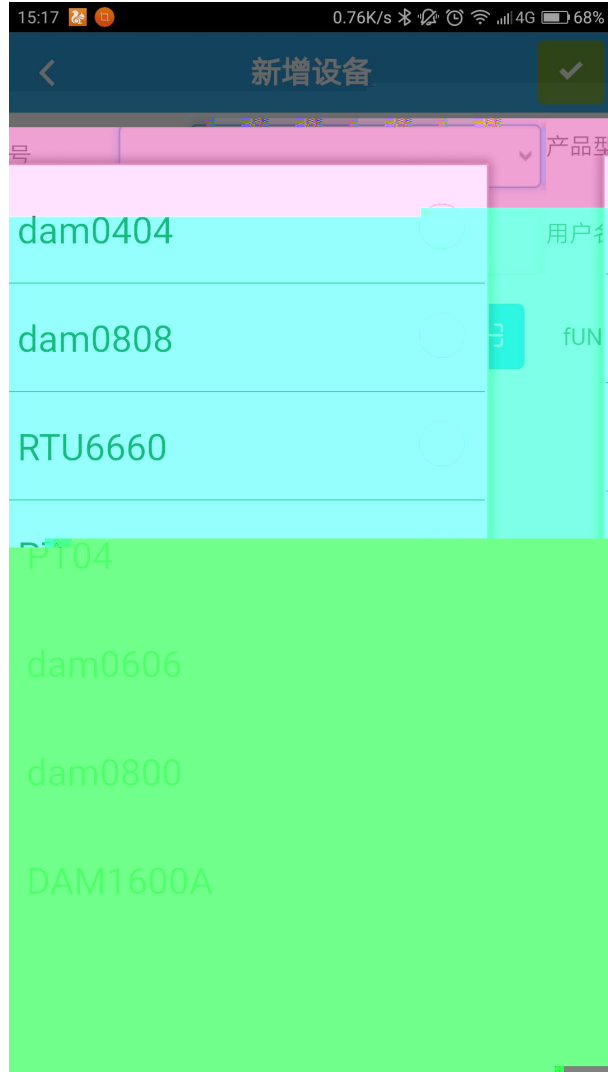

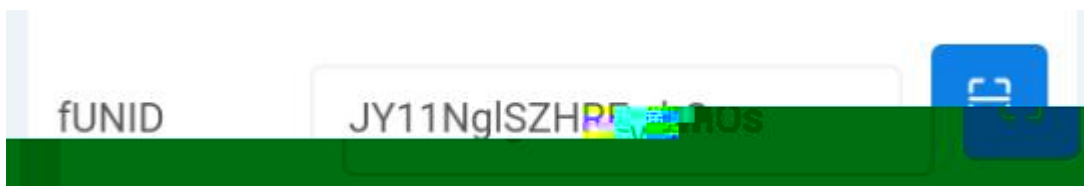
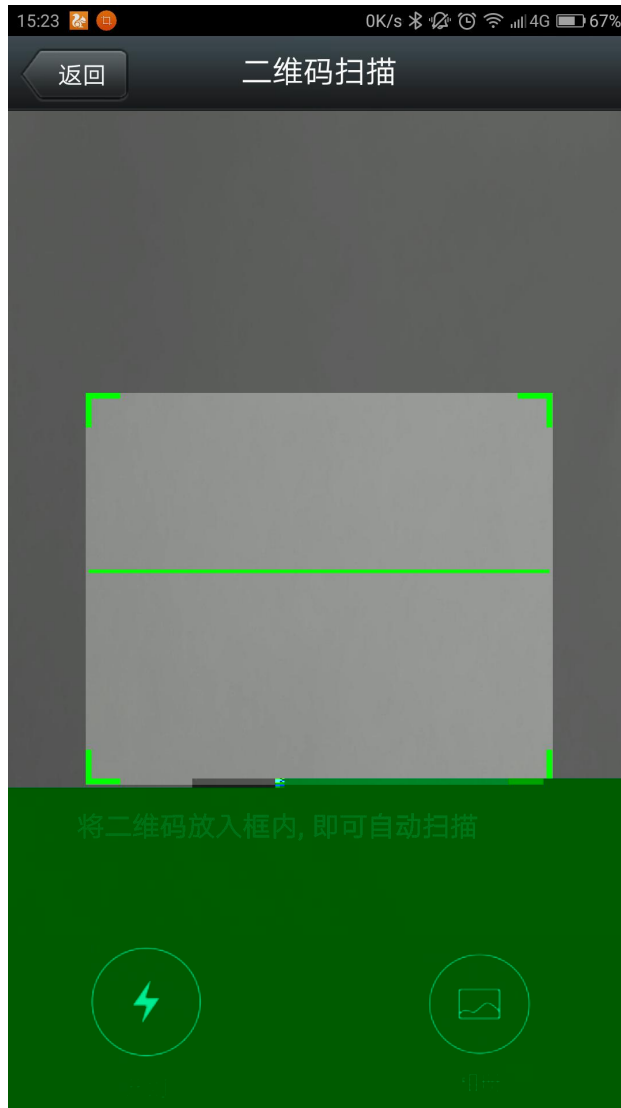

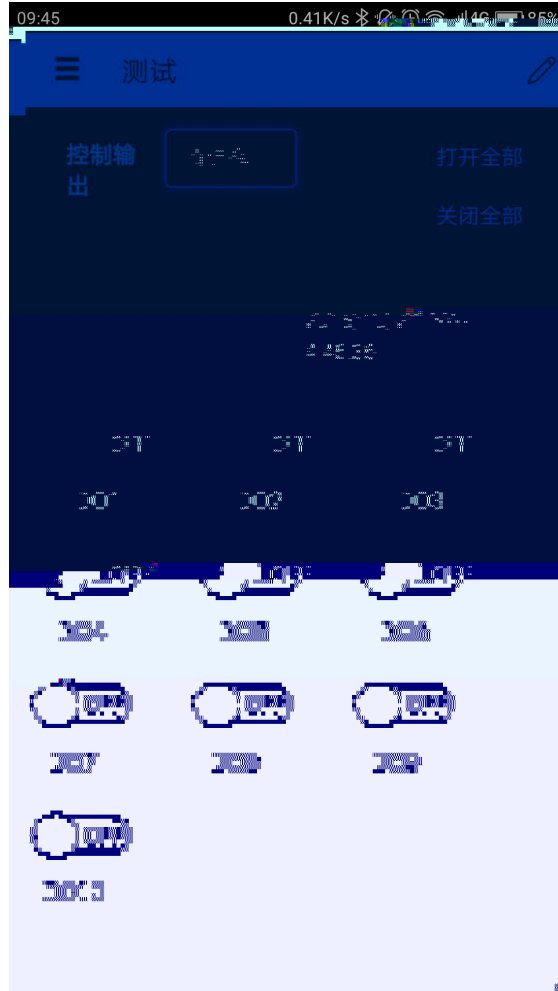



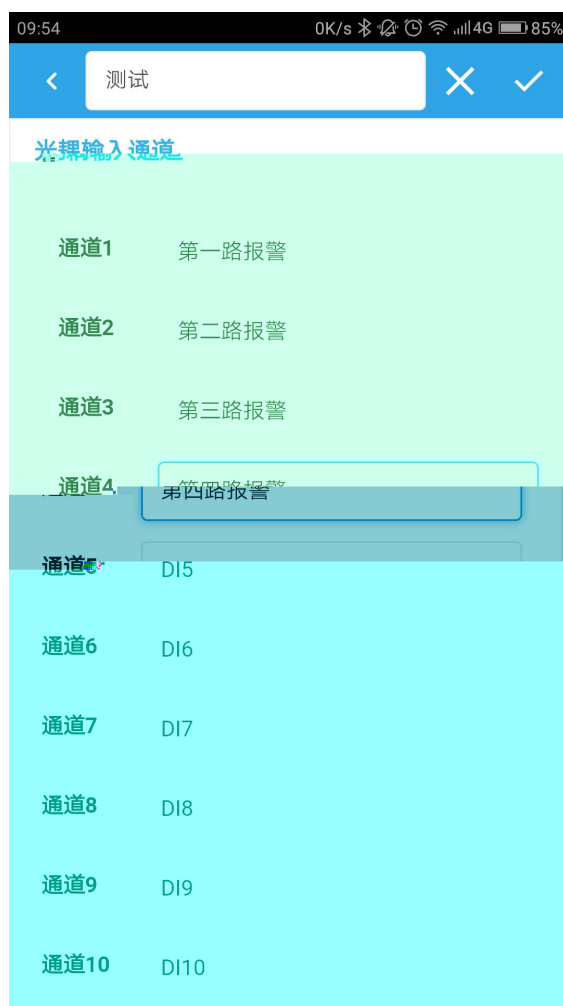

通道
序号

通道

通道序号	电流值1	电流值1 对应数据	电流值2	电流值2 对应数据
通道	4000	0	20000	100



1

10

2

3

FE 10 00 03 00 02 04 00 04 00 0A 00 D8
FE 10 00 03 00 02 04 00 02 00 14 21 62

FE 10 00 03 00 02 A5 C7

4

	OF	
00 00		
<i>31 D2</i>	<i>71 92</i>	

--	--	--

