

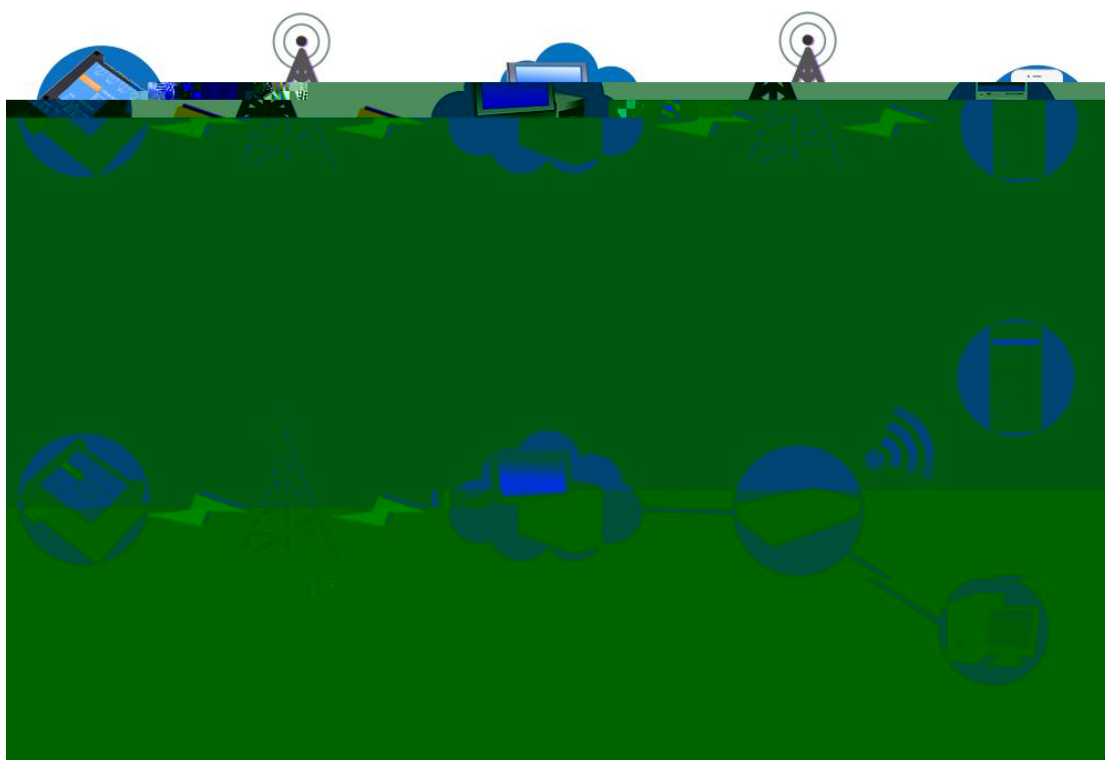

-
-
-
-
-

-
-
-
-

一、使用移动网络



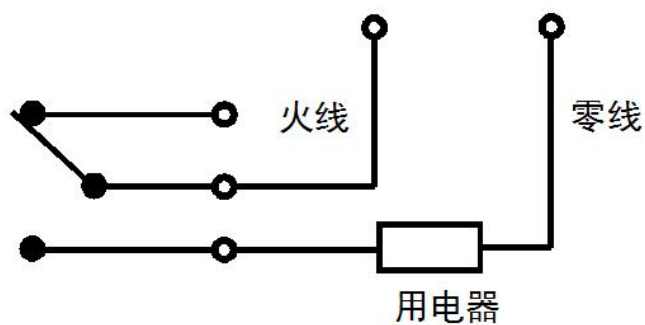
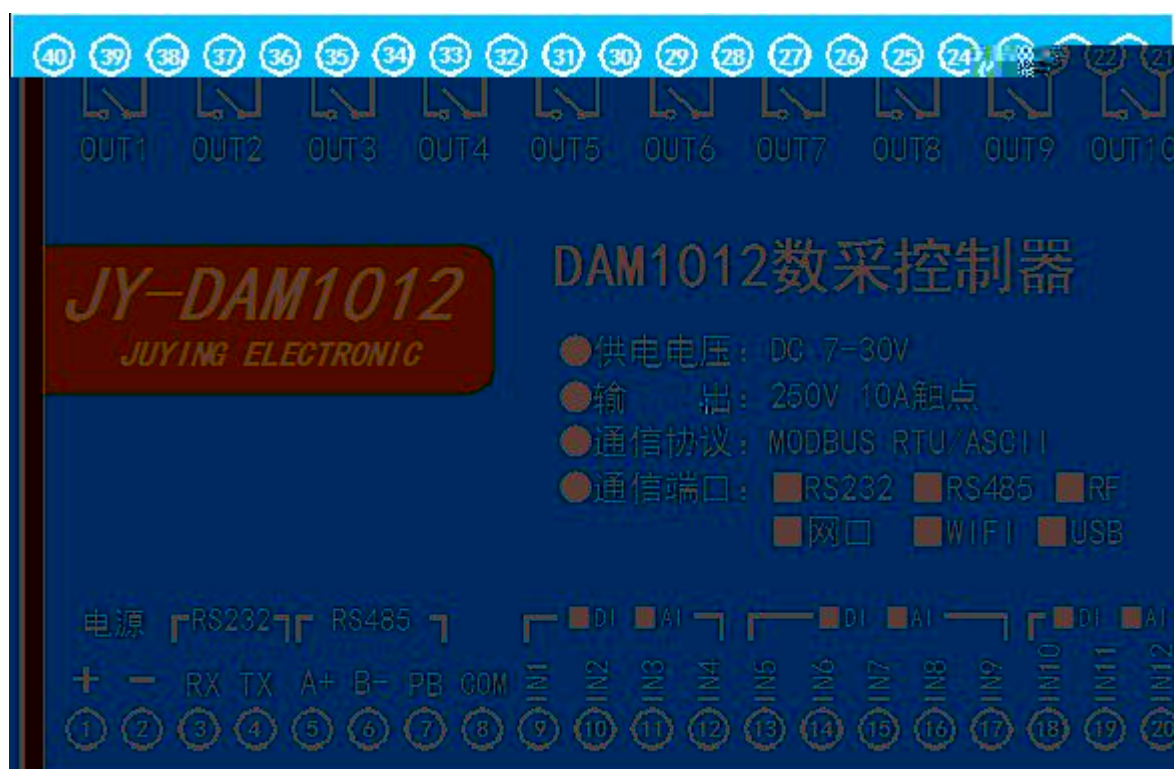

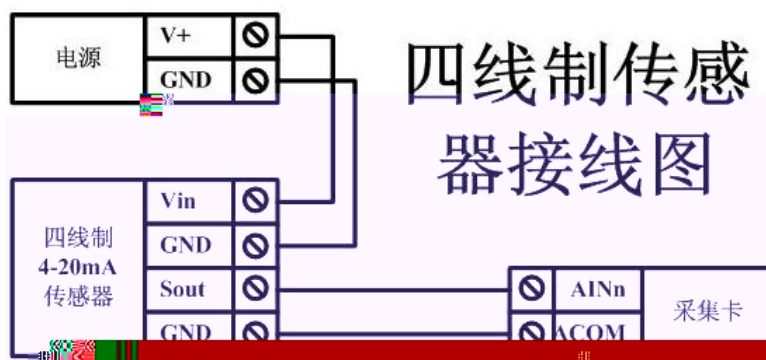
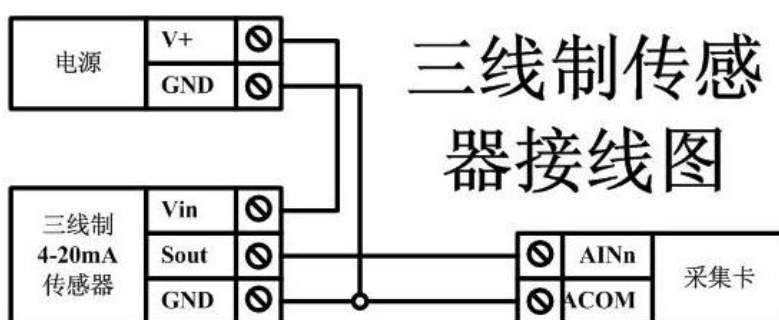
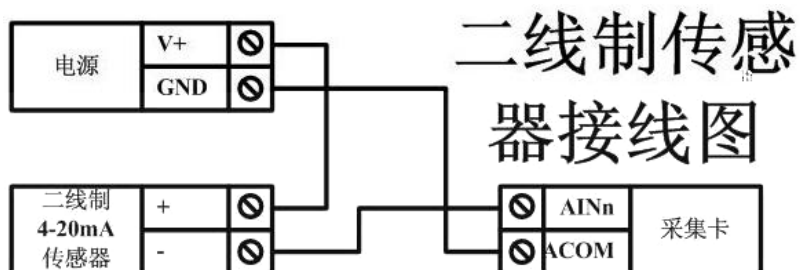





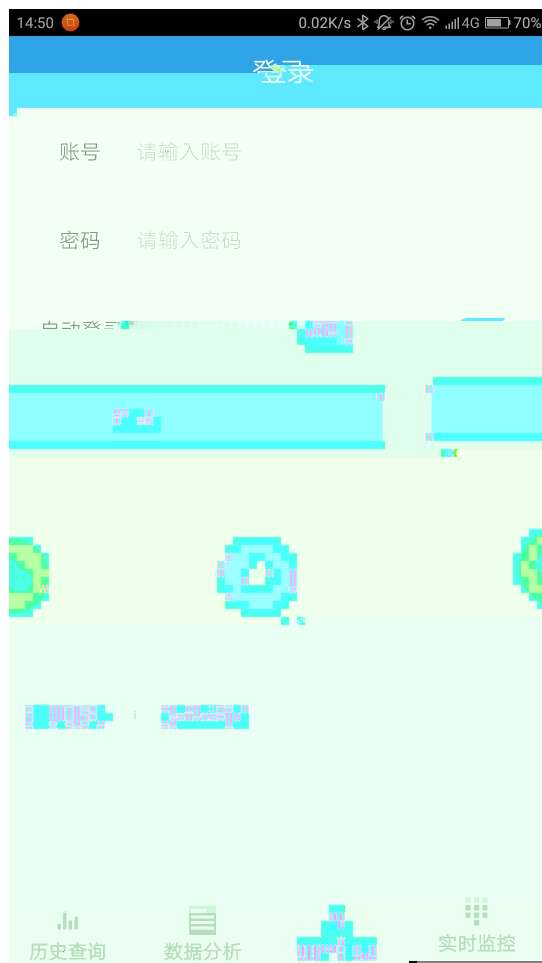

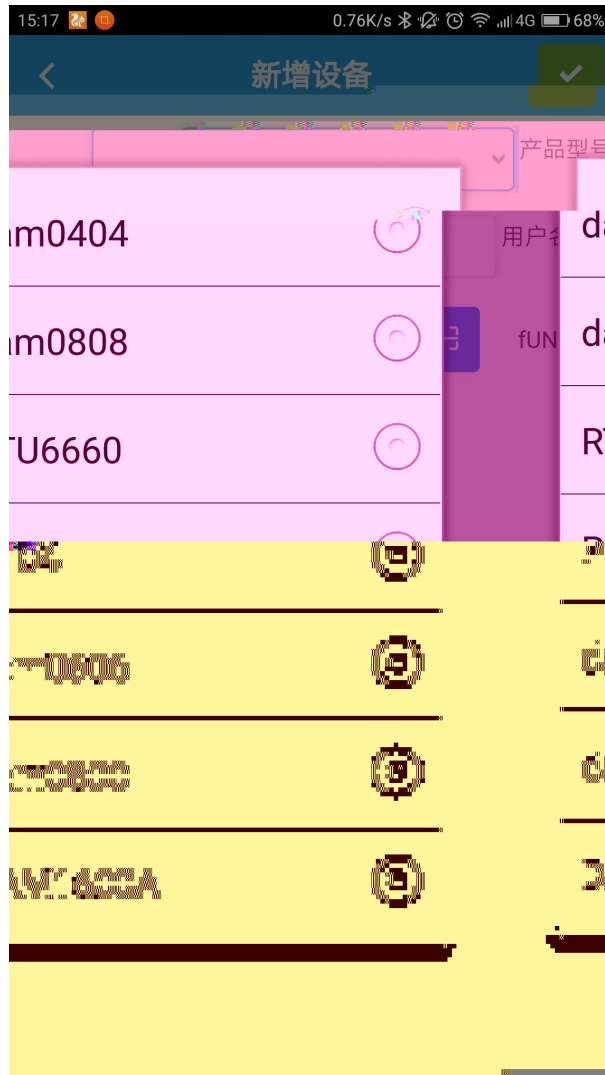

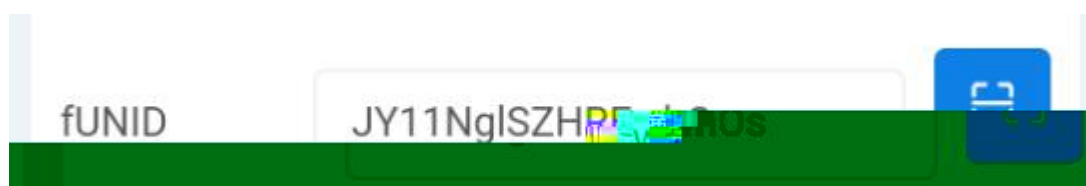
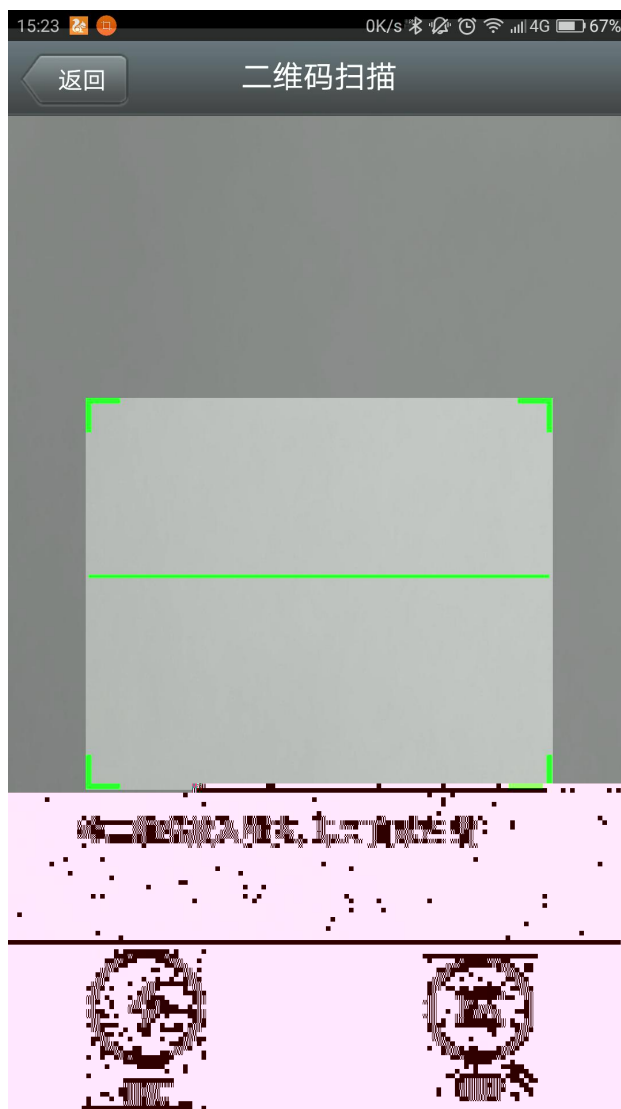

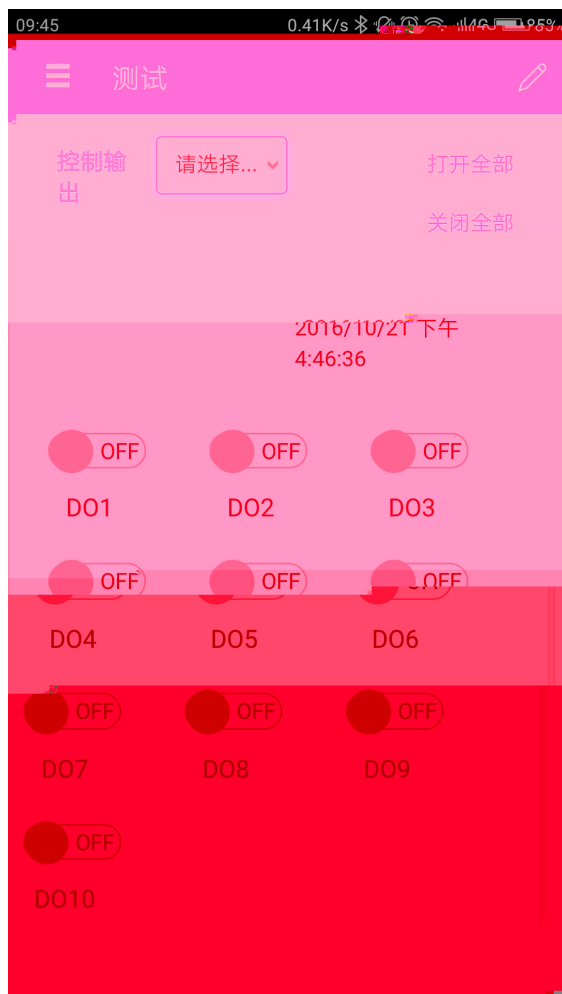

明

明明

明明



通道序号

电流值1

电流值1
对应数据

电流值2

电流值2
对应数据

通道

4000

0

20000

100

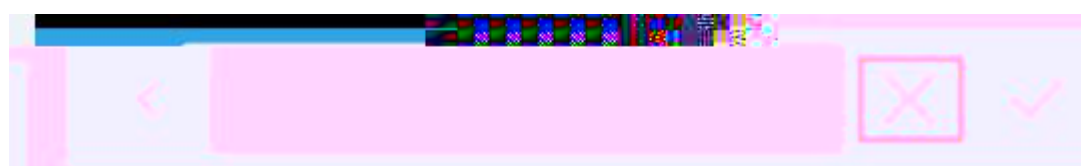
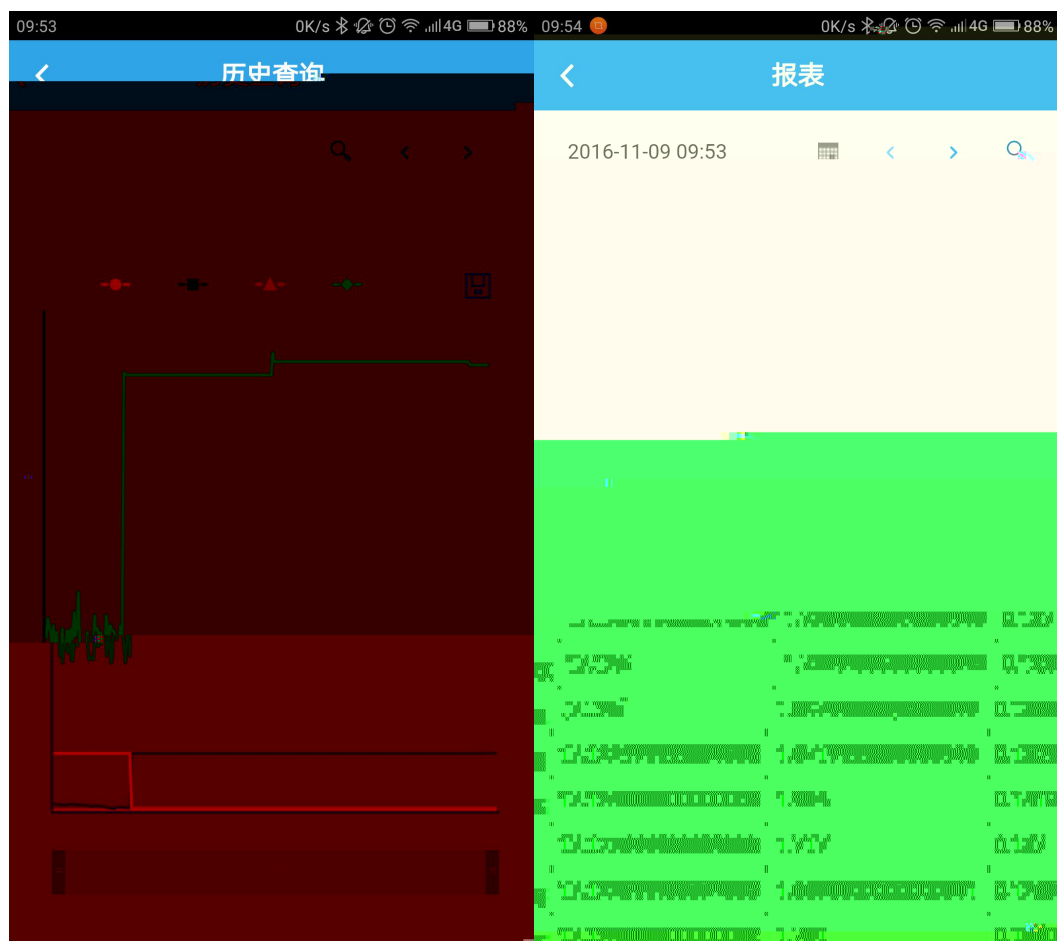

FE 04 00 00 00 01 25 C5

FE 01 00 00 00 0A A8 02

--	--

