



2016 01

-
-
-
-
-
-
-
-
-

-
-
-
-
-
-
-
-
-
-
-

一、使用移动网络

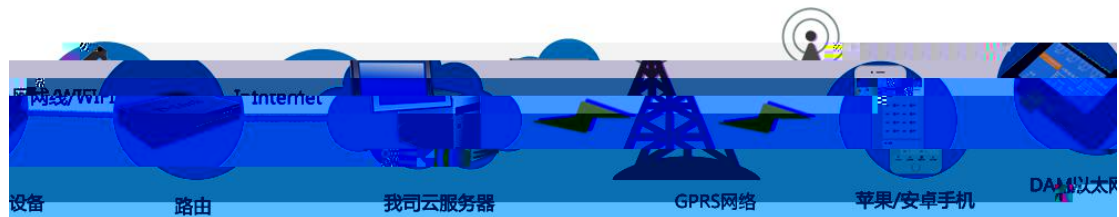

二、使用WIFI或者有线网络



1

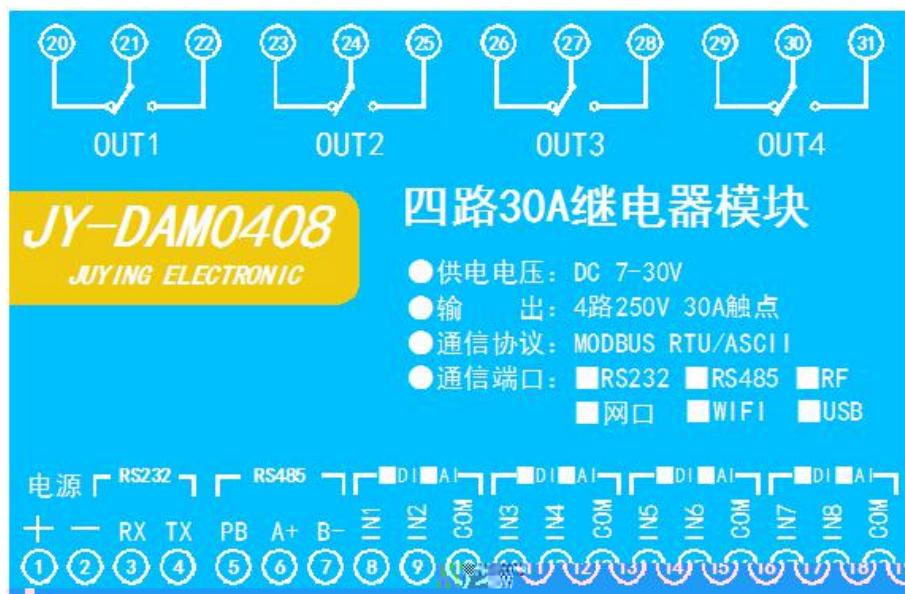

2

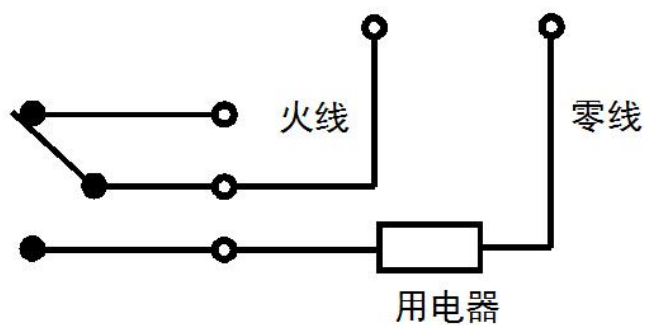

2

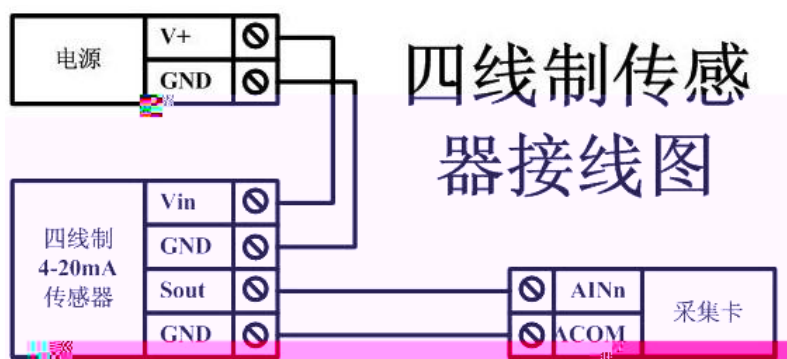
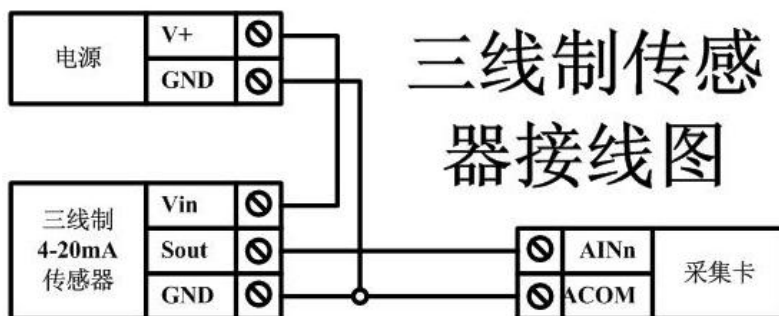
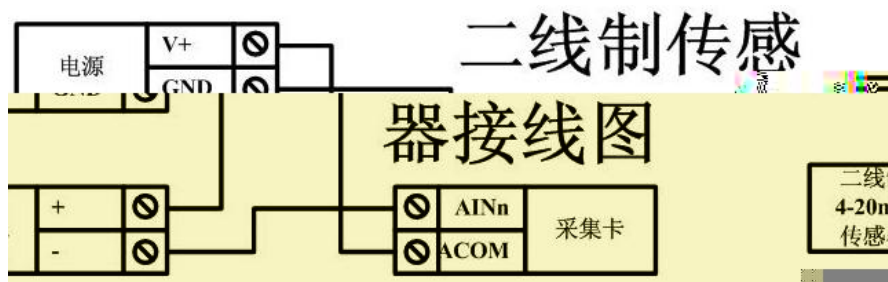

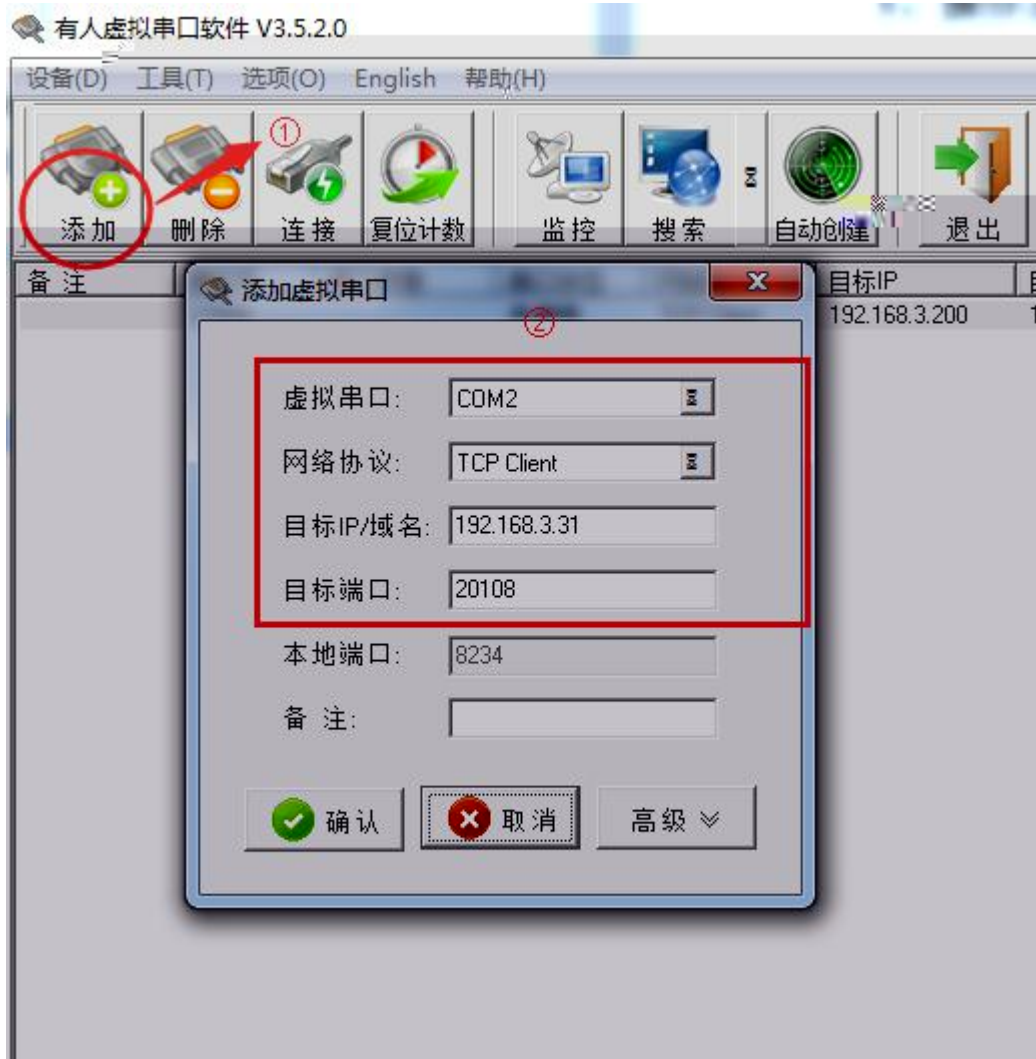

备注	串口号	串口参数	串口状态	网络协议	目标IP	目标端口	本地端口	串口接收	网络接收	网络状态	注册ID
	COM4		未使用	TCP Client	192.168.3.200	10000	--	0	90	已连接	0

○

唯一ID

DAM调试软件

串口设置

串 口 COM4 (V) 波特率 9600 关闭串口 打开全部继电器 【DAM0404A】: 【继电器 4】 【光耦 4】 【模拟量 0】

设备型号 DAM0404A 设备地址 254 读取地址 关闭全部继电器 读继电器 读光耦 读模拟量 调试信息

继电器

光耦

通	模拟量	数值	单位
1	AI1	0.000000	
2	AI2	0.000000	
3	AI3	0.000000	
4	AI4	0.000000	
5	AI5	0.000000	
6	AI6	0.000000	
7	AI7	0.000000	
8	AI8	0.000000	
9	AI9	0.000000	
10	AI10	0.000000	
11	AI11	0.000000	
12	AI12	0.000000	
13	AI13	0.000000	
14	AI14	0.000000	
15	AI15	0.000000	
16	AI16	0.000000	

清空

读取DI
读取DI
读取DI
读取DI
读取DI
读取DI
读取DI
读取DI
读取DI
读取DI

2)

1

2 Modbus



DAM0408A- WFI +



Q, E ED
@ ó vA

