

V1.0



2016 7

.....	1
.....	1
.....	2
.....	2
.....	3
.....	6
.....	6

1

JY-DAMLC

2

-
-
-
-
-
-
-
-

()

-
-

H20
316L
304

-
-
-
-
-
-
-
-
-
-

:0~1 50mH20
4~ 20mA RS485 Modbus-RTU
(01-10VDC 0-5VDC 1-5VDC 0.5-2.5VDC)
:12~36VDC
.25%FS 10m
-40 60
-40 85
-10 60
: 10g(20... 200OHZ)
:200%

- 500Hz
- 5Hz
- 0.1% FS/
- :+0.01%FS/
- 290g
- 60g
- : IP68
- 0.02Us(W)

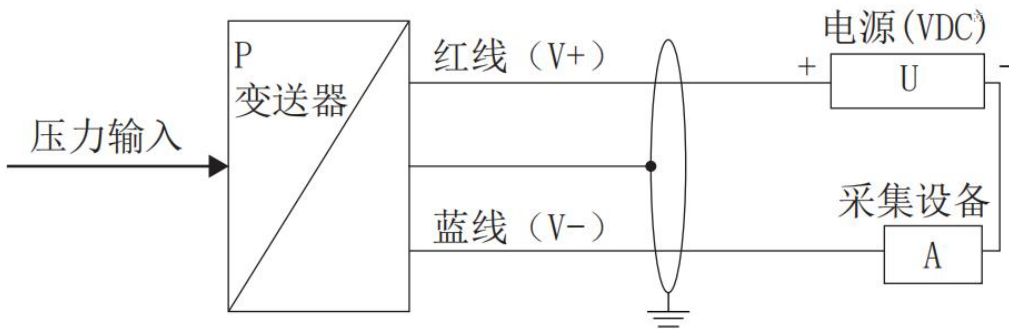
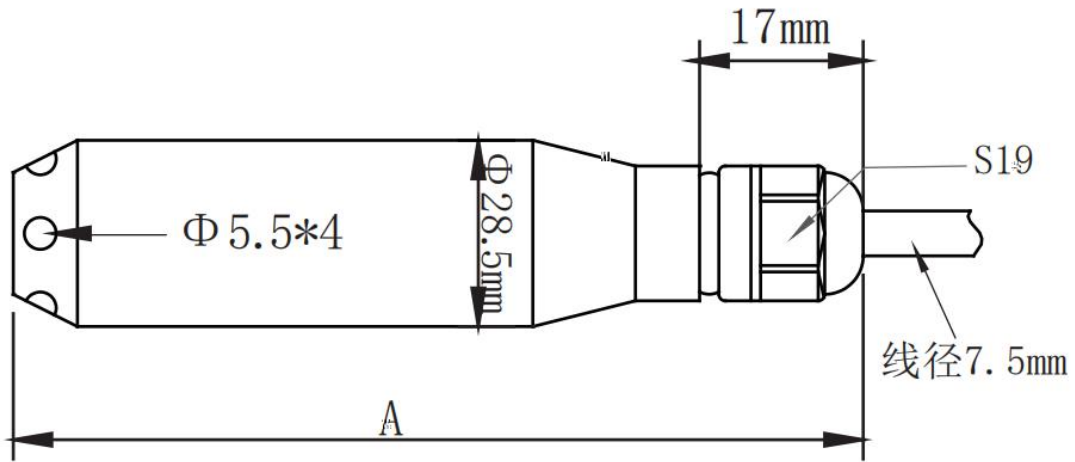

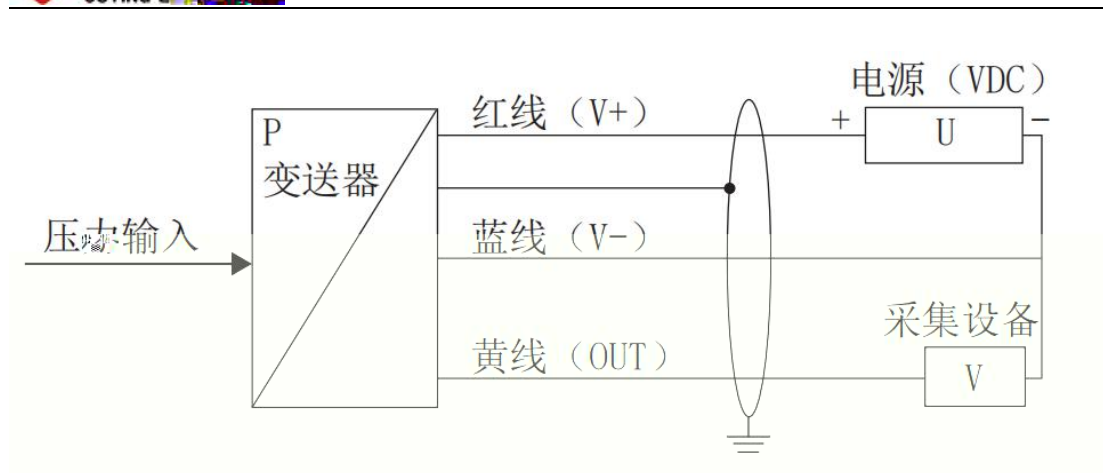

a)

b)

c)

d)

e)

f)

g)

h)

PVC

5mm

7-1

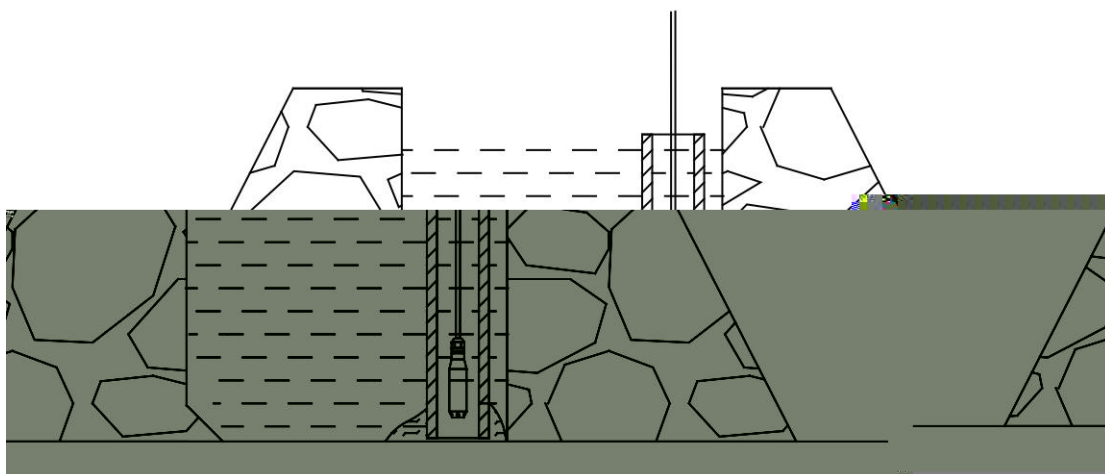

i)

j)

k)

l)

GB/T50312-2016

m)

n)

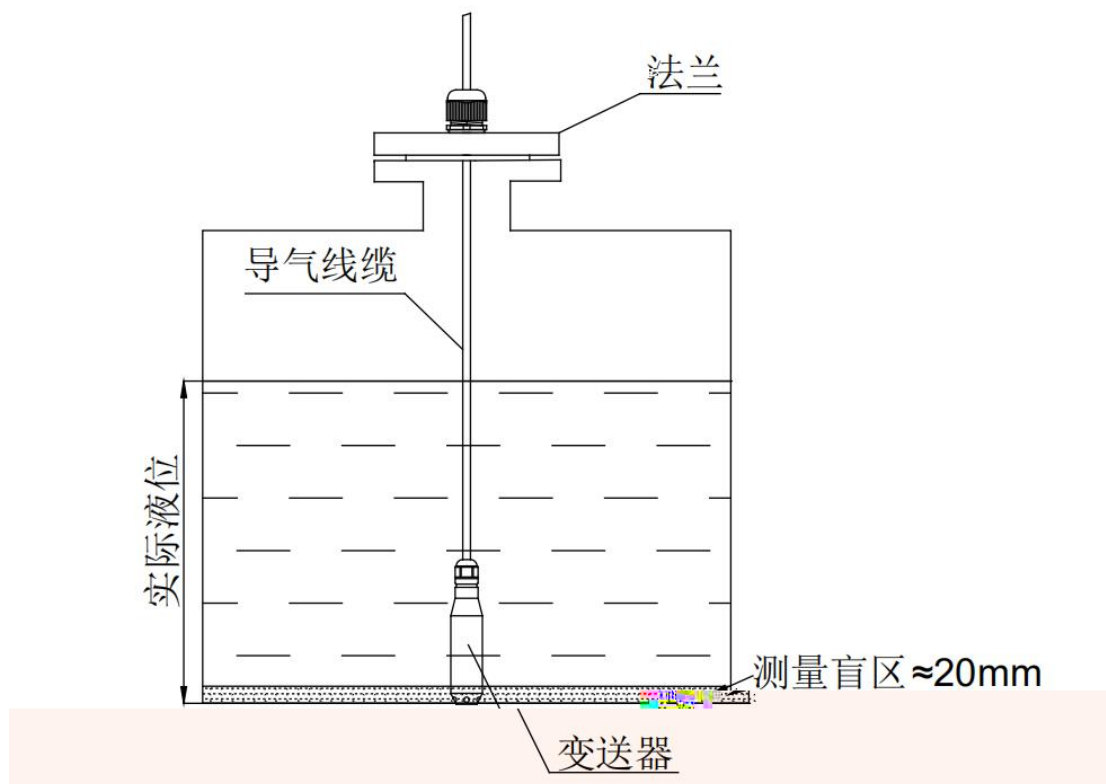
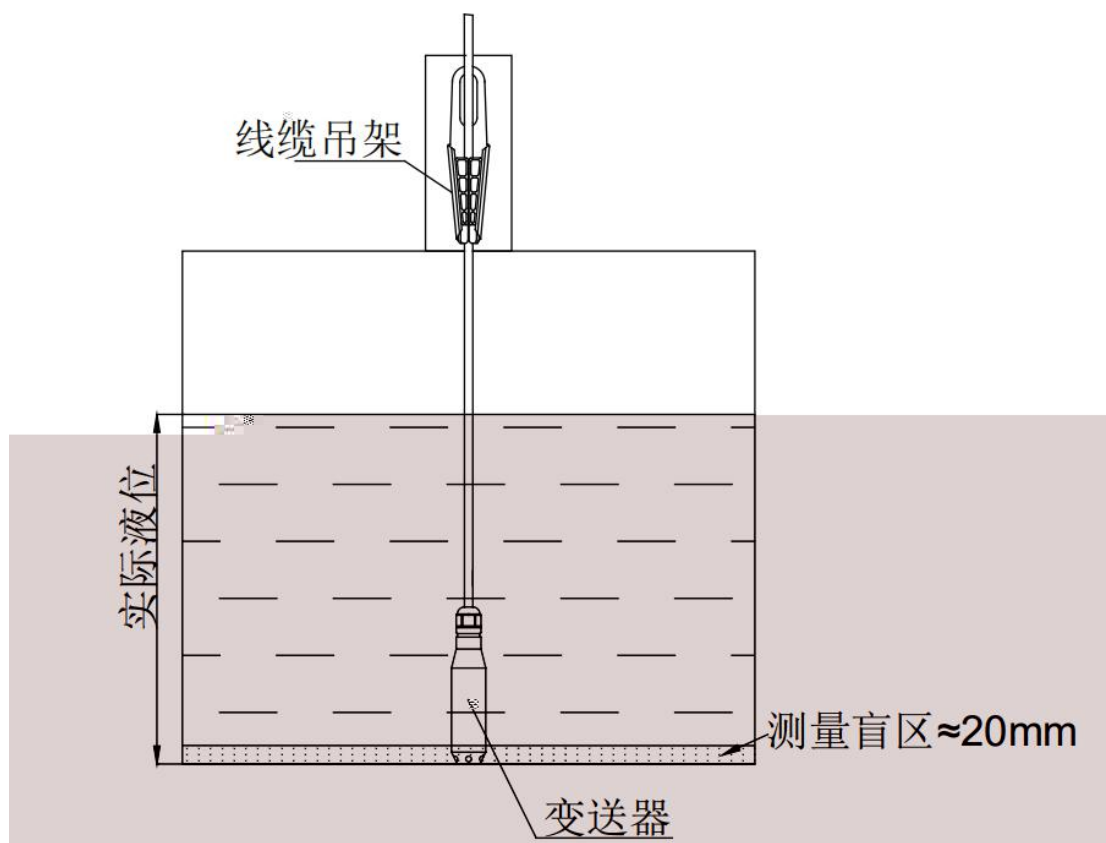

.	.	.
.	.	.
.	.	.

JYDAM

<https://www.juyingel.com/download/JYDAMSoftware.zip>

<https://www.juyingel.com/download/JYNetConfig.zip>
)

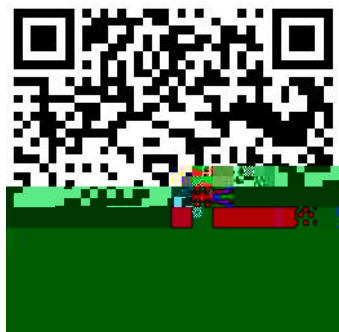

JYDAM



