



	1
1	1
2	1
3	1
4	1
	2
	3
1 4 5	3
2 4-20 /0-10	3
	4
1 4 5	4
2	4
	5
1	5
2	5
3	6
5	7
	10
1	10
2	10
3	10
	12
1	12
2	12
	13
	13
	14

1

2

- 7-30
- 4 5
-
-

78E 0A9 €D •A9 €D ~ë

3FÄñ)TvƒTQ PU•Wr'#1" 1Y' Y †VA •

-
-
-
-

	4 5	4-20 /0-10	
- 2-			- 4 5
- 2- 2			-4-20
- 4-			- 4 5
- 6-			
- 7-			2.5

	4 5
	7-40
	0 5000 (50 +3%)
	0 1 . 1 25
	-40 120 0.3
	0-100% 2.0%
	300-1100 1
	0 300 / 2
2.5	0-1000 / 3 10%
	4-20 -40-120 0-100% 0-10 -40-120 0-100%
	13 * 7
	600, , 1
	2400,4 00, 600,1 200,3 400

1 RS485

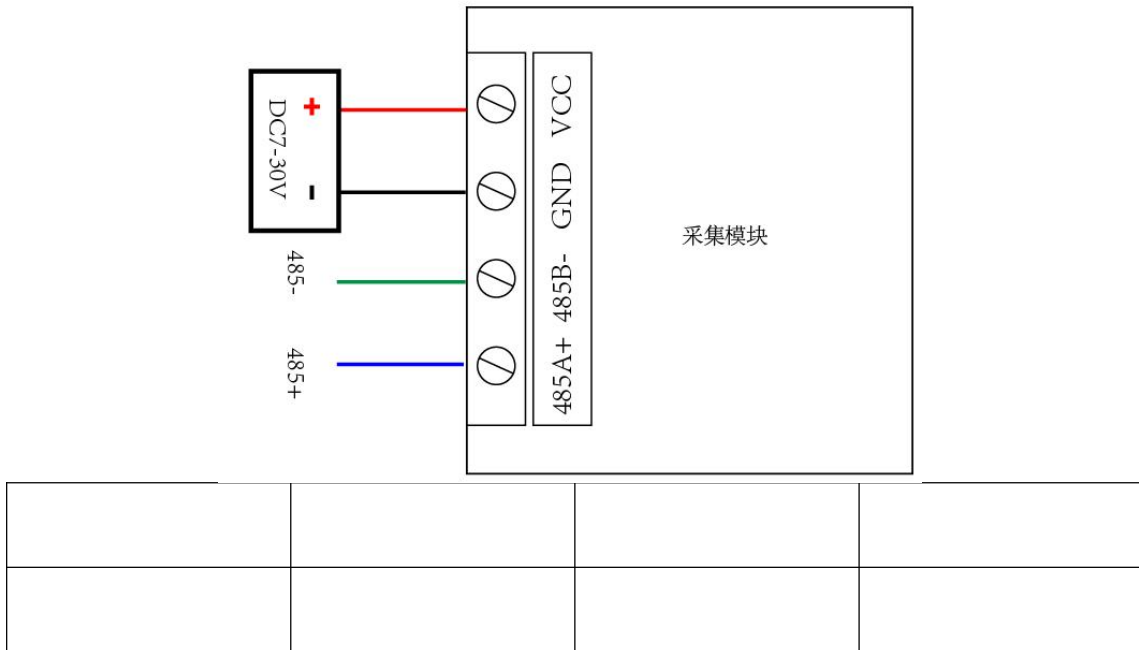

2 4-20mA/0-10V

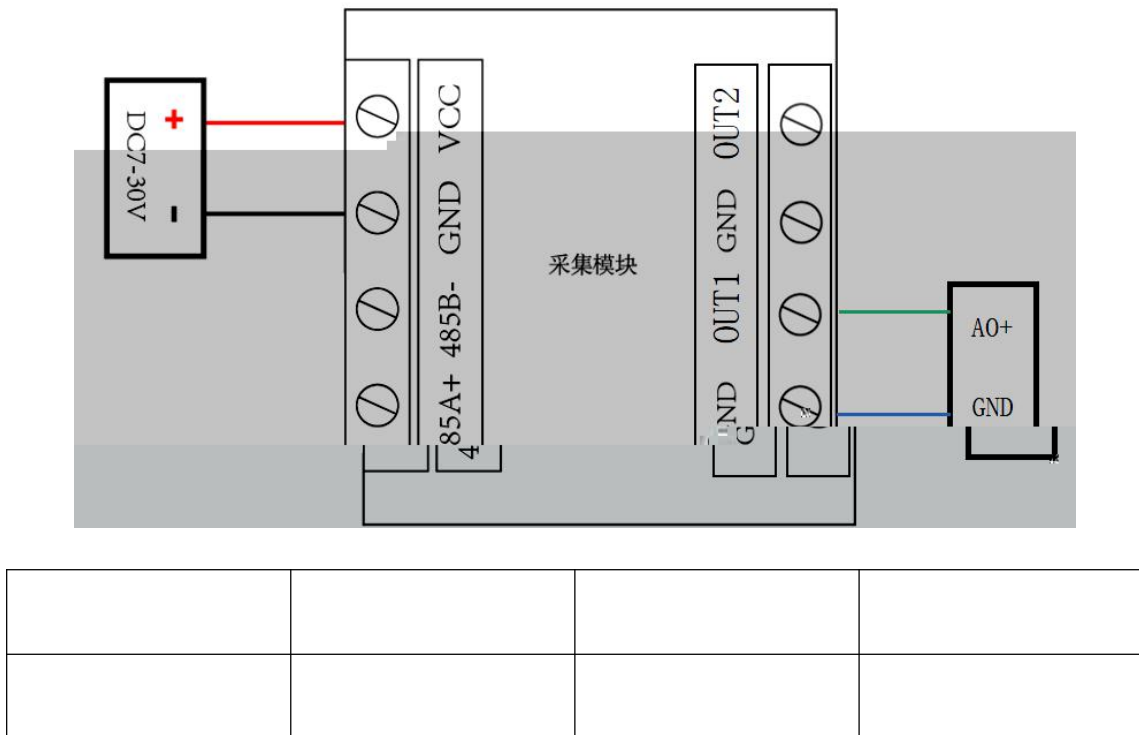

1 RS485

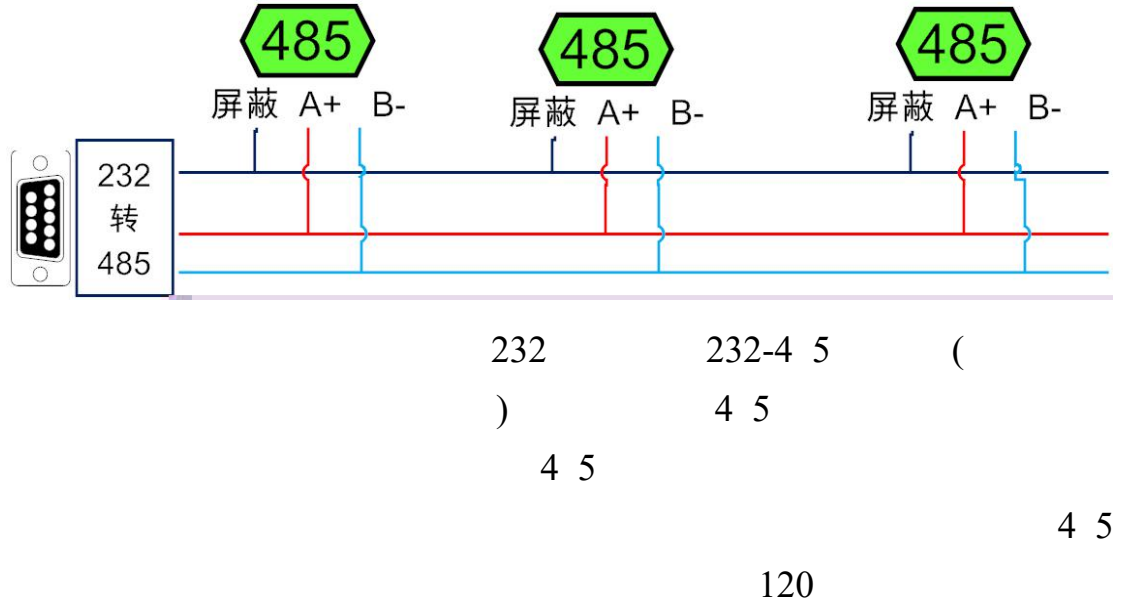

2

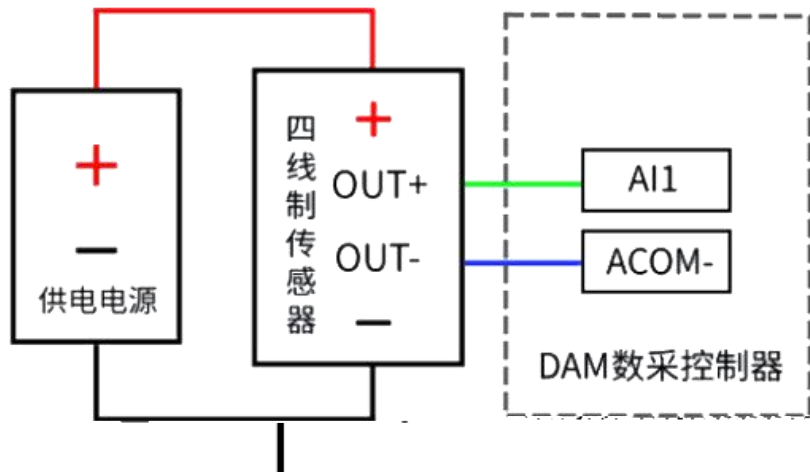

1

Modbus

<http://www.juyingele.com.cn/software/software.htm>

0 7		0 600 1 2400 2 4 00 3 600 4 1 200 5 3 400 6 115200 7 57600 56000 14400 10 1200
		0 1 () 2 ()
10 11		0 1 1 2 2 1.5

3

	(16)	
	04 00 00 00 01 2	0
	04 02 0 01 44	0 01 25.61
	04 00 01 00 01 4 0	1
2	04 00 02 00 01 4 0	2
	04 00 03 00 02 4	3 4
	04 00 0 00 01 3 4	5
	04 00 0 00 01 4	6
2.5	04 00 0 00 01 4 04	7
	04 00 00 00 0 3	

	(16)	
	04 03 00 01	
	04 02 00 02 2	02
	0 03 00 02 3 4	02
	0 03 00 02 3 4	02

5

04 00 00 00 01 2

04	04	
00 00		
00 01		
25 5	16	

04 02 00 00 24

04	04	0 2
02		1+(-1)/
00() 00()		
24	16	

04 00 01 00 01 4 0

04	04	
00 01		
00 01		
74 05	16	

04 02 00 00 24

04	04	0 2
02		1+(-1)/
00() 00()		
24	16	

04 00 02 00 01 4 0

--	--	--

04	04	
00 02		
00 01		
4 05	16	

04 02 03

04	04	0 2
02		1+(-1)/
03		0 3 1000
	16	

04 00 03 00 02 4

04	04	
00 03		
00 02		
5 4	16	

04 04 00 3 00 4

04	04	0 2
04		1+(-1)/
00 36	16	0 36 00 35 42.40
00	16	
4 5	16	

04 00 00 00 0 3

04	04	
00 00		
00 0		
5 4	16	

04 10 00 00 00 00 00 00 00 00 00 00 00 00 00 00 00 00 1 2

04	04	0 2
10		1+(-1)/
00 00		
00 00		
00 00		
00 00	16	
00 00	16	
00 00		
00 00		
00 00		2.5
71 2	16	

0 03 00 02 3 4

06	06	
03		
00 02		
3 4	16	

0 03 00 02 3 4

06 06
03
00 02
3 4

1

<http://www.juyingle.com.cn/software/software/DAM>

.rar

2

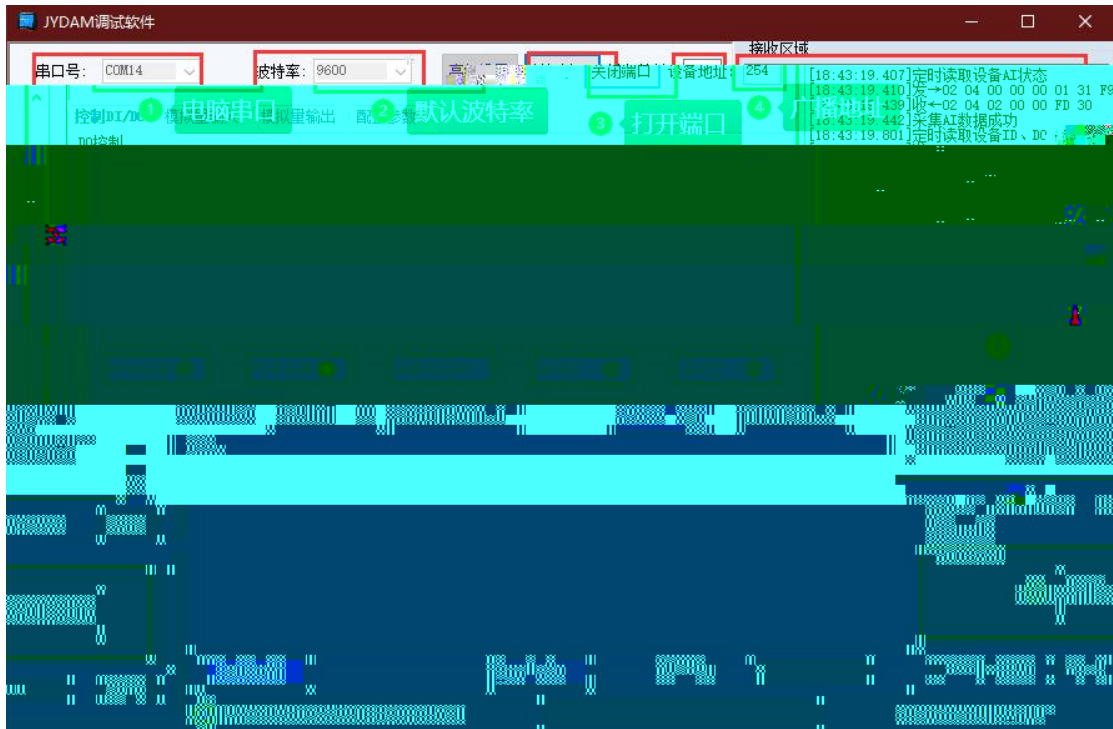

600

3

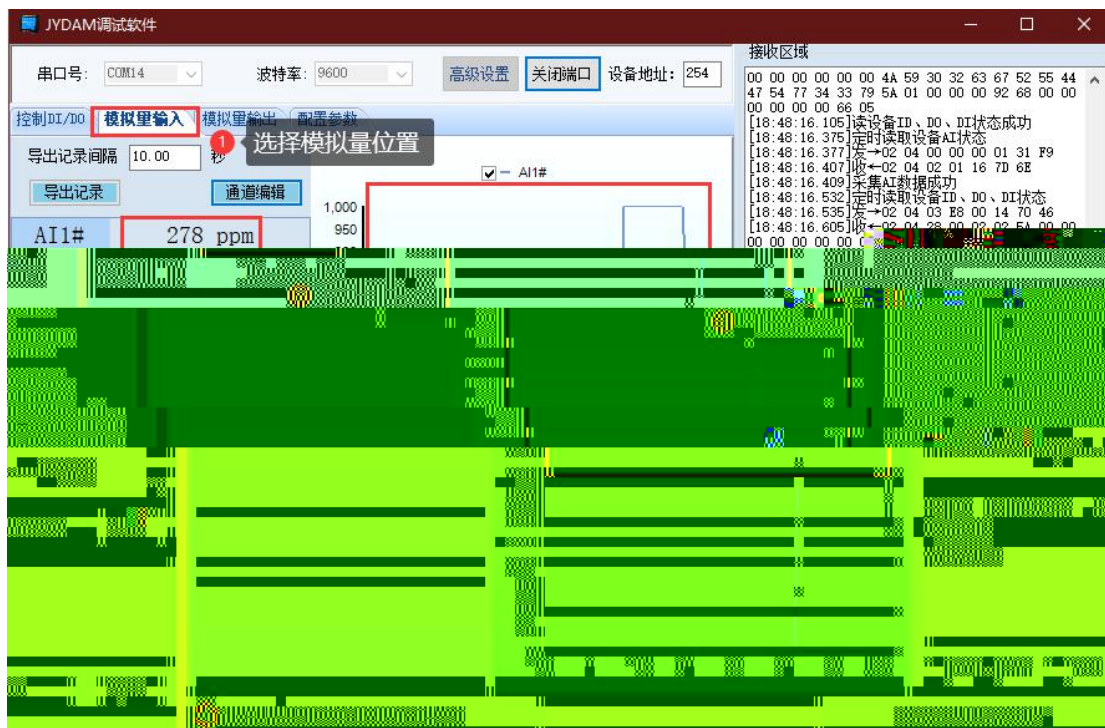

1

1.1

1 254 0

=

1.2

254

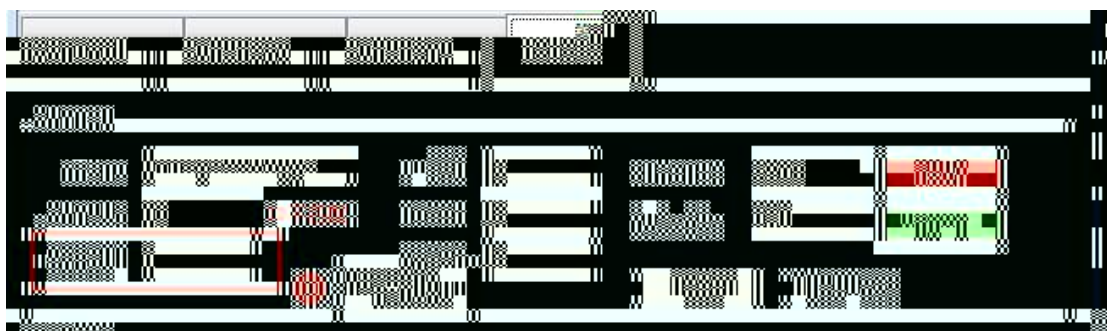

1.3

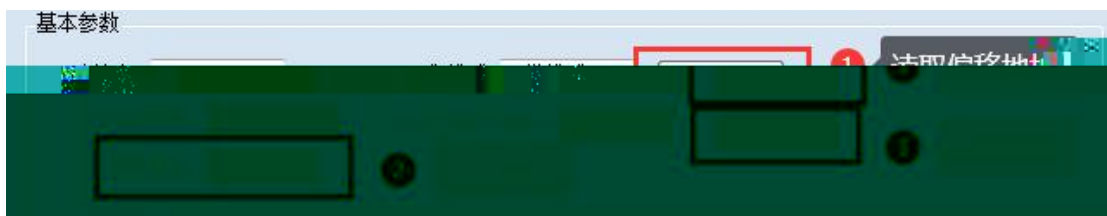

2





1 485

254

2

4 0 20

3

4

12

5

5

400-66 -400 010- 2 27/1- 03

33237252 4 2 67 445

