

DAM 4862

V1.1



2017 01

-
-
-
-
-
-
-
-
-
-

()

	modbus	RS232	RS485	USB	WiFi		AD		
DAM4862						2	14	8	6

	10A/30VDC 10A/250VAC
	10
	RS485 RS232
	DC 7-30V
	1 LED
	2 LED
	-40 85
	145*94*41mm
	330g
	9600, n, 8, 1
	Labview

JY-DAM14862
JUYING ELECTRONIC

DAM14862数据采集器

- 供电电压：DC 7-30V
- 输出：250V 10A触点
- 通信协议：RS-485、MODBUS RTU/ASCII
- 通信接口：RS-485、RS-485、RF

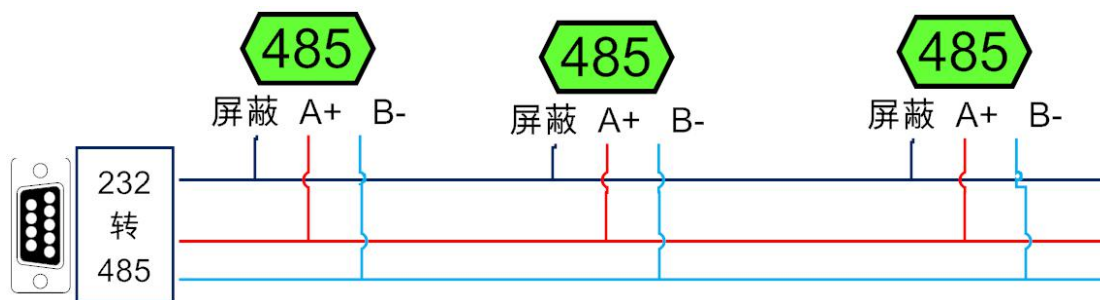

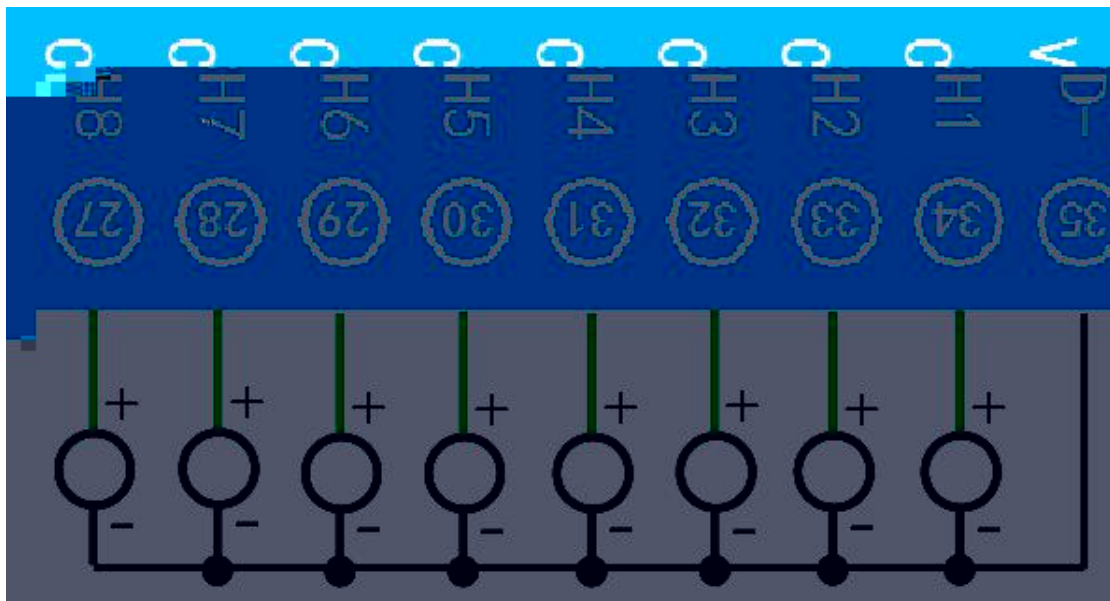
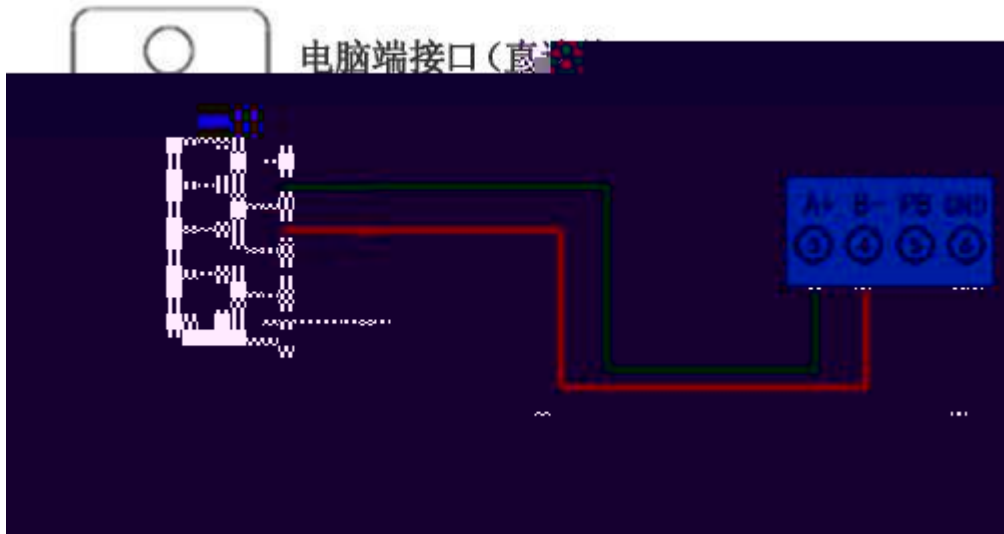

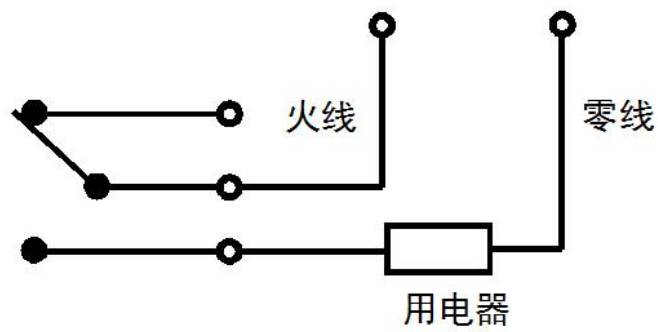
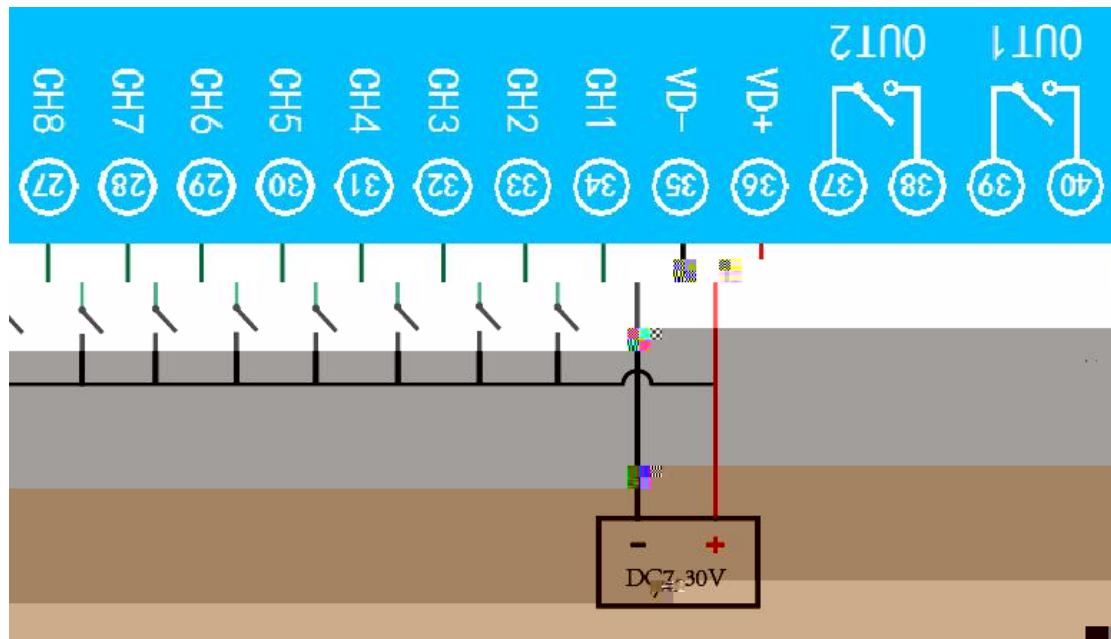

$$= \frac{AI}{*0.001}$$

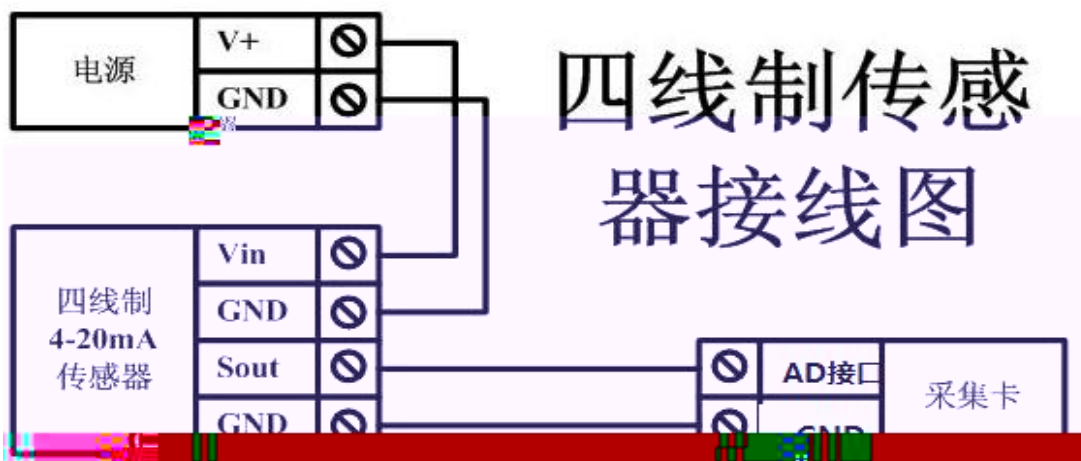
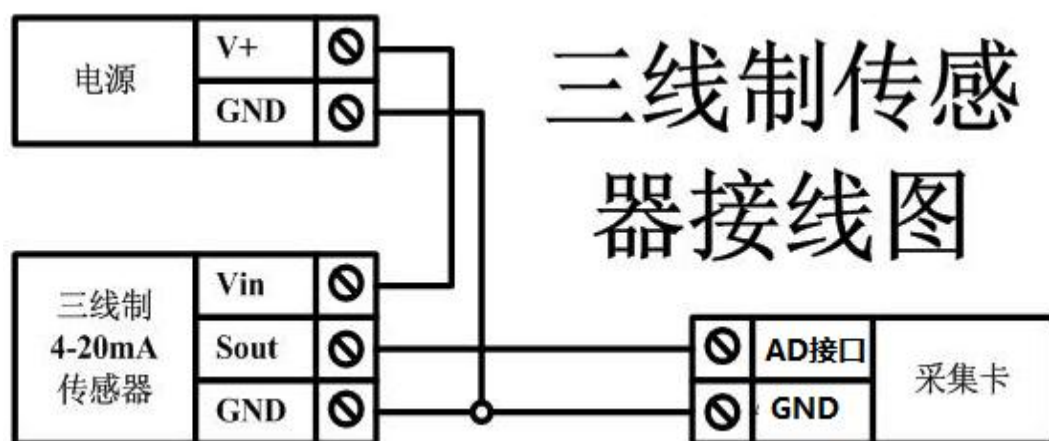
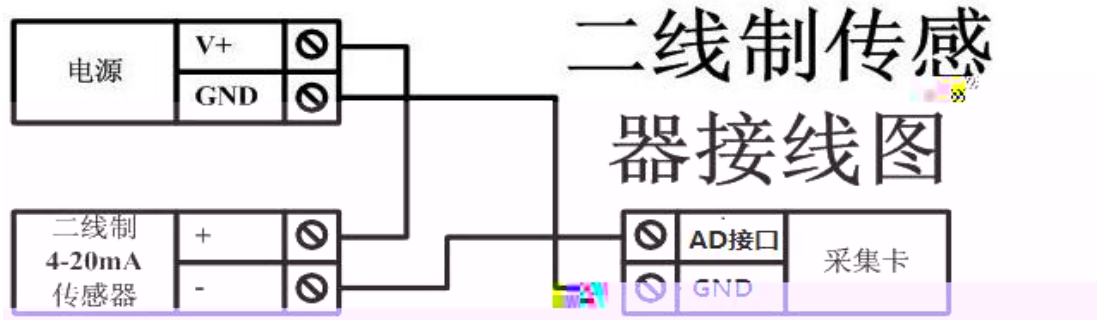

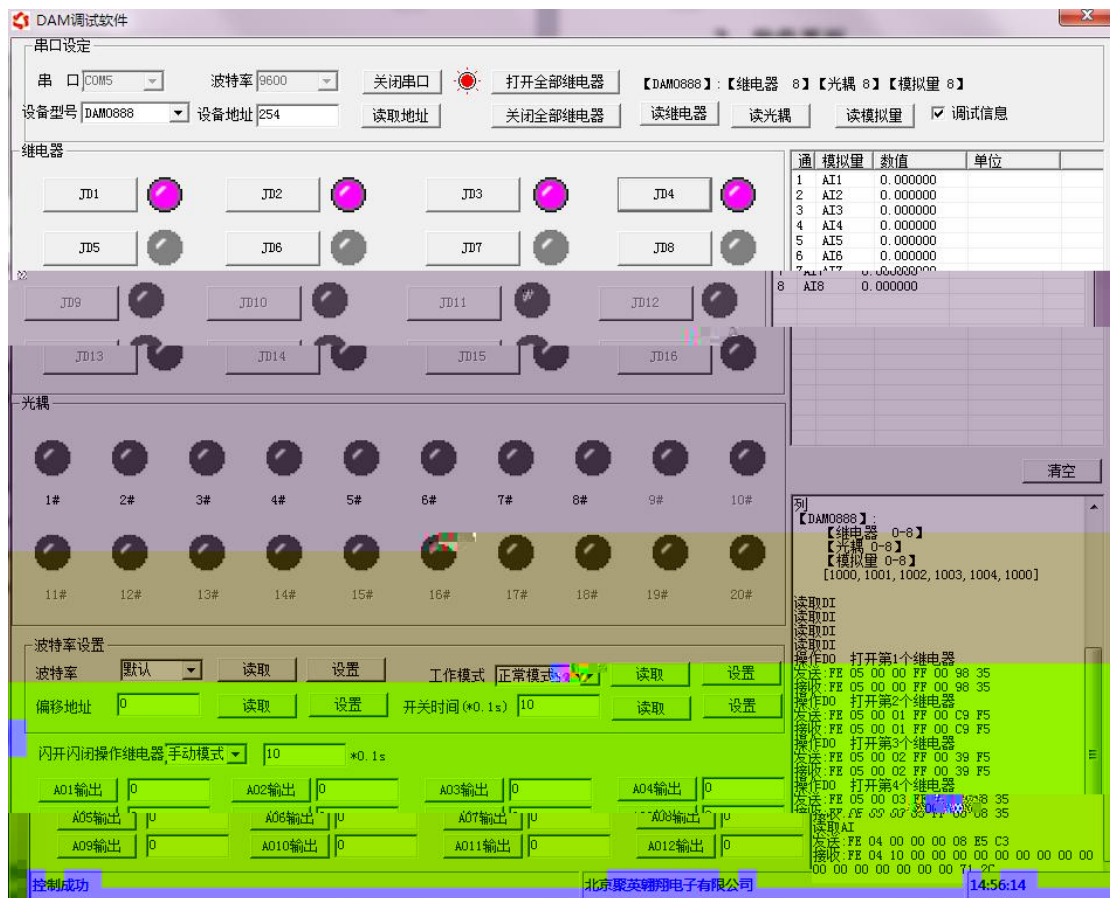

-
-
-
-
-
-
-
-

- ①
- ②
- ③

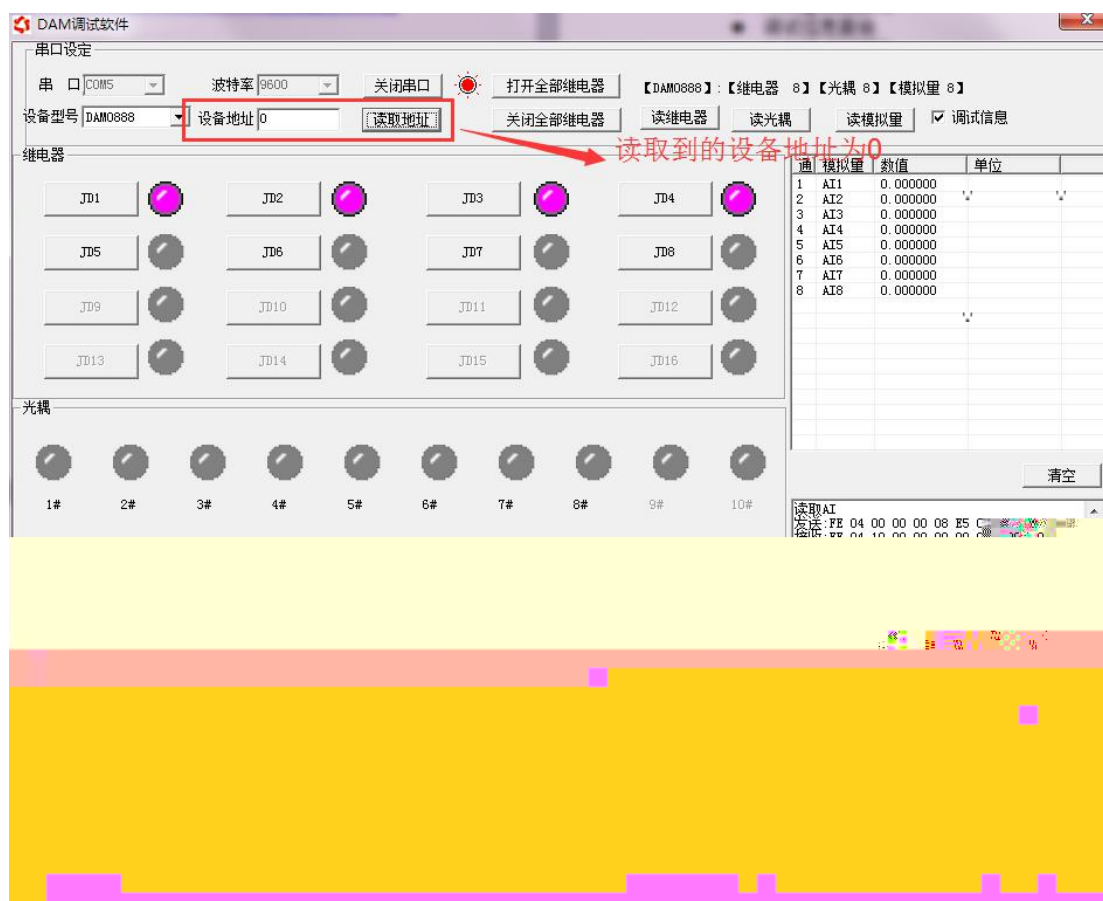

1.1

= +

0

1.2

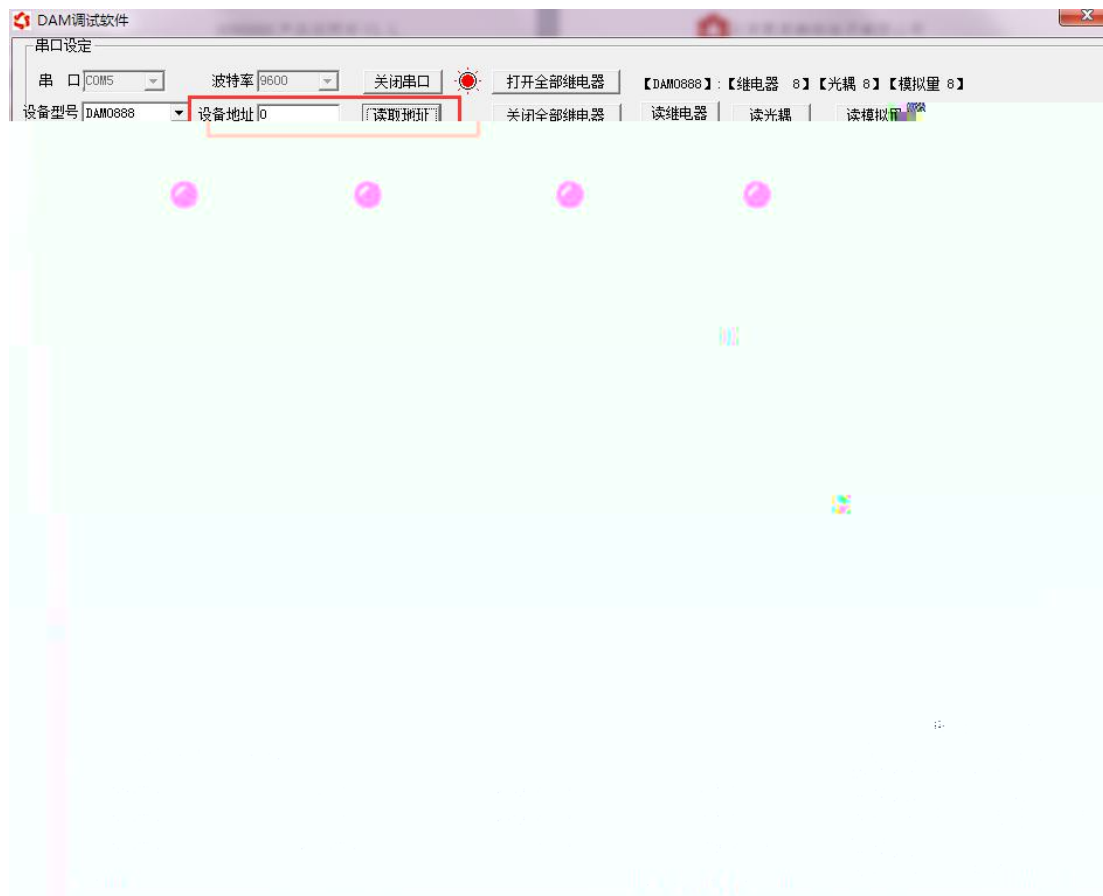

1.3



1.4

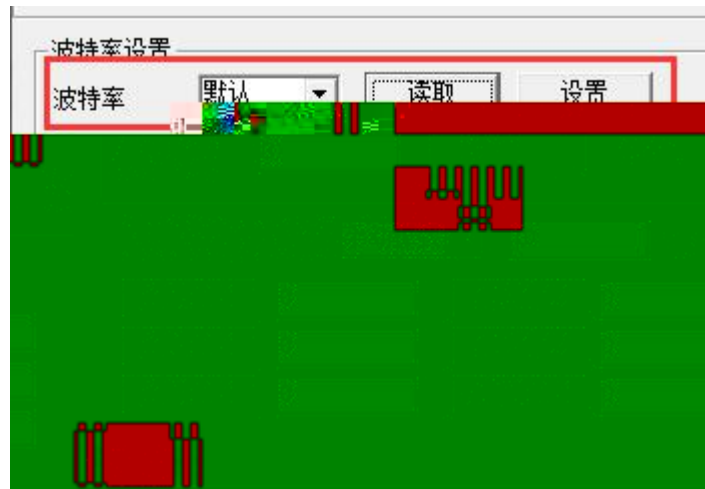

2.1

2.2

" DAM "

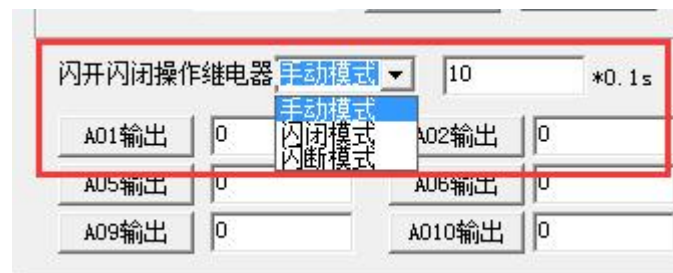

()

00f

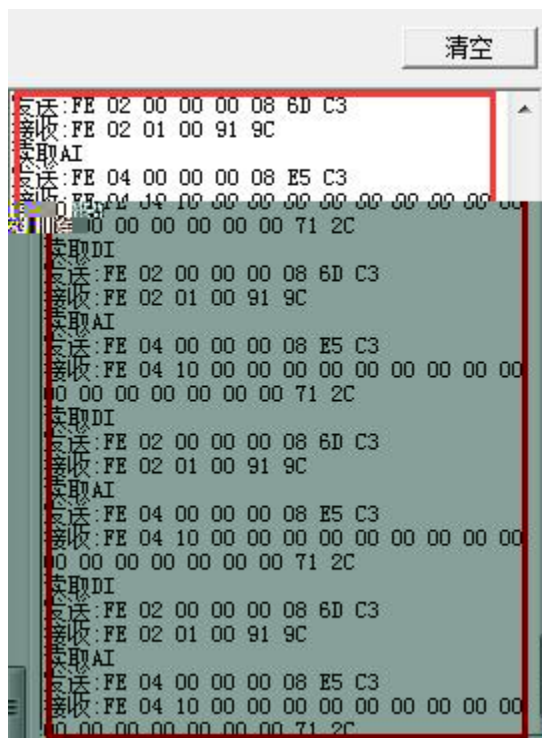

	04 00 00 00 0
	3
	03 04 0 00 01 0
	2
	03 04 1 00 01 1
	12
	03 04 2 00 01 31
	12
	03 04 3 00 01 0
	2

	03 04 4 00 01 1 13
	03 04 00 01 0 3
	03 04 0 00 0 1 10
	03 0 14 00 01 0
	03 0 1 00 01 1 0
	03 0 1 00 01 1 0
	03 0 1 00 01 20
	03 0 1 00 01 10
	03 0 1 00 01 41 0
	03 0 14 00 0 1 0
	03 0 00 01 10 0
	03 0 00 01 41 10
	03 0 00 01 1 10
	03 0 00 01 0 0
	03 0 00 01 1 11
	03 0 00 01 00 1
	03 0 00 0 1 12
	03 0 00 01 1 33
	03 0 00 01 00 3
	03 0 00 01 0 3
	03 0 00 01 1 33
	03 0 0 00 01 1 3
	03 0 1 00 01 0
	03 0 00 0 10 1

5.1

1

5.2

2

01 00 00 00 02 4

		()

5.3

FE 10 00 03 00 02 04 00 04 00 0A 00 D8

FE 10 00 03 00 02 04 00 02 00 14 21 62

		()

FE 10 00 03 00 02 A5 C7		

5.4

AD
04 00 00 00 0 1

		()

5.5

02 00 00 00 0 3

)

		()

5.6

FE OF 00 00 00 02 01 FF D1 D3
FE OF 00 00 00 02 01 00 91 93

	OF	
00 00		
(
<i>D1 D3</i>	<i>91 93</i>	

FE OF 00 00 00 02 00 05

	OF	
00 00		
<i>00 05</i>		

5.7

03 0 14 00 01 0

		()

1 232

2 485 1 255 1
1

3 PLC

JYDAM

<https://www.juyingelectronics.com.cn/software/software/JYDAM%E8%B0%B3%E8%AF%95%E8%BD%AF%E4%BB%B6.rar>

<https://www.juyingelectronics.com.cn/software/jynet/%E4%BB%A5%E5%A4%AA%E7%BD%91%E9%85%8D%E7%BD%AE%E8%BD%AF%E4%BB%B6.rar>

()



JYDAM

