

DAM1066

V1.1



2015 11

-
-
-
-
-
-
-
-
-
-
-
-
-
-
-
-

	modbus	RS232	RS485	USB	WiFi			
DAM066-RS232/485						10	6	6

	10A/30VDC 10A/250VAC
	10
	RS485 RS232
	DC 7-30V
	1 LED
	10 LED
	-40 85
	145*94*41mm
	330g
	9600, n, 8, 1
	Labview

JY-DAM1066
JUYING ELECTRONIC

DAM1066数采控制器

- 供电电压: DC 7-30V
- 输出: 250V 10A触点
- 通信协议: MODBUS RTU/ASCII
- 通信端口: RS232 RS485 RF
 网口 WIFI USB

电源 RS232 RS485

+	-	RX	TX	A+	B-	PB	COM	IN1	IN2	IN3	IN4	IN5	IN6	IN7	IN8	IN9	IN10	IN11	IN12
1	2	3	4	5	6	7	8	9	10	11	12	13	14	15	16	17	18	19	20

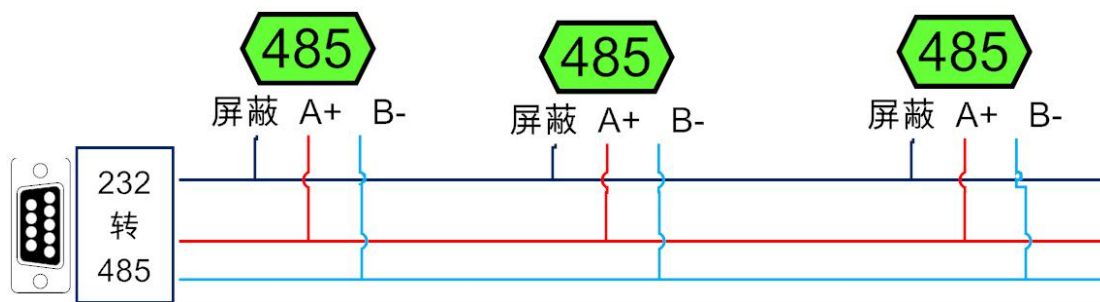

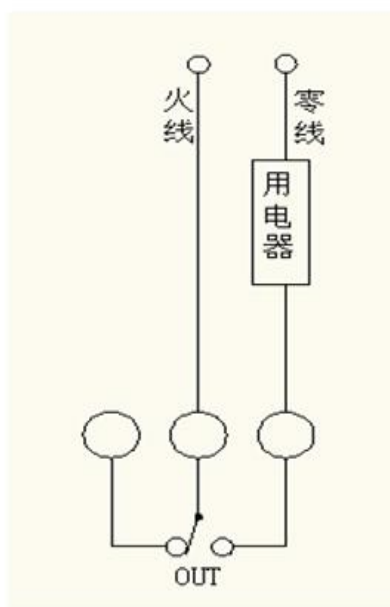
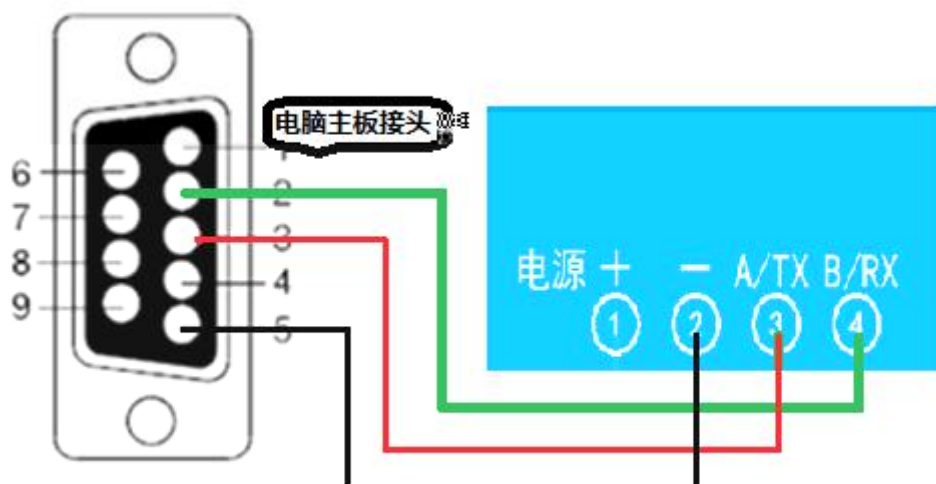

$$= \frac{AI}{ACOM} * 0.001 \quad AI \quad Nh \quad I \quad N$$

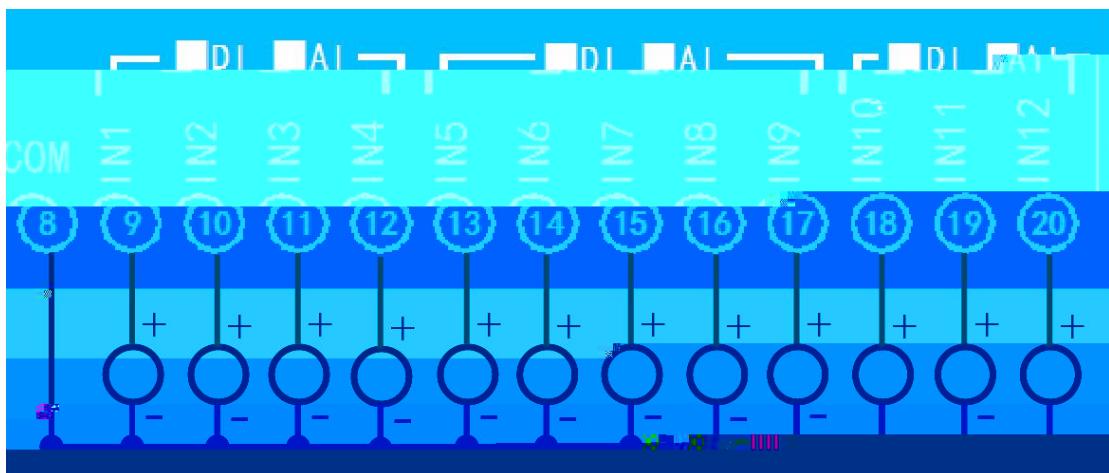
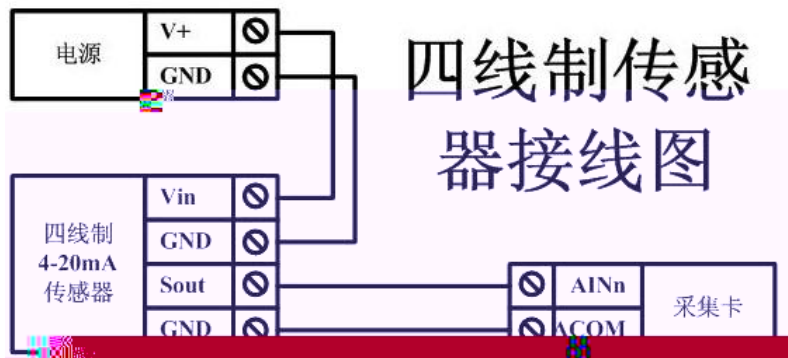
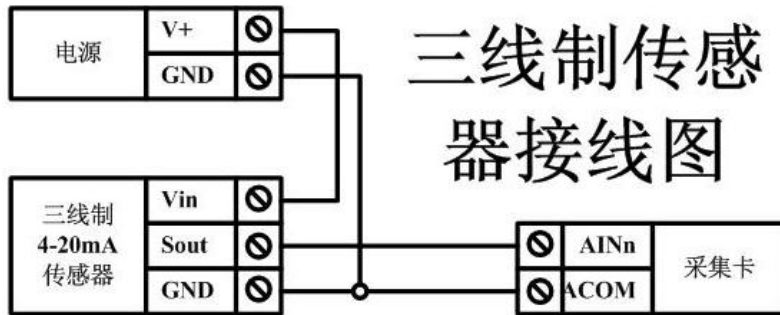
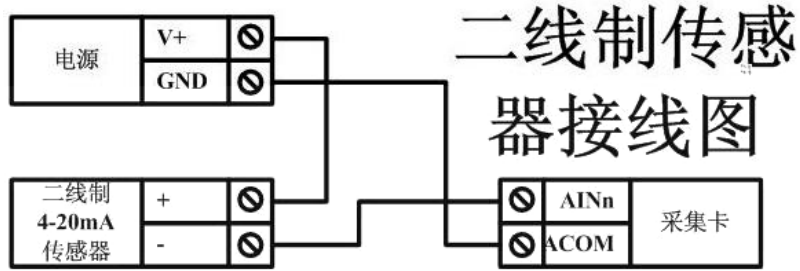

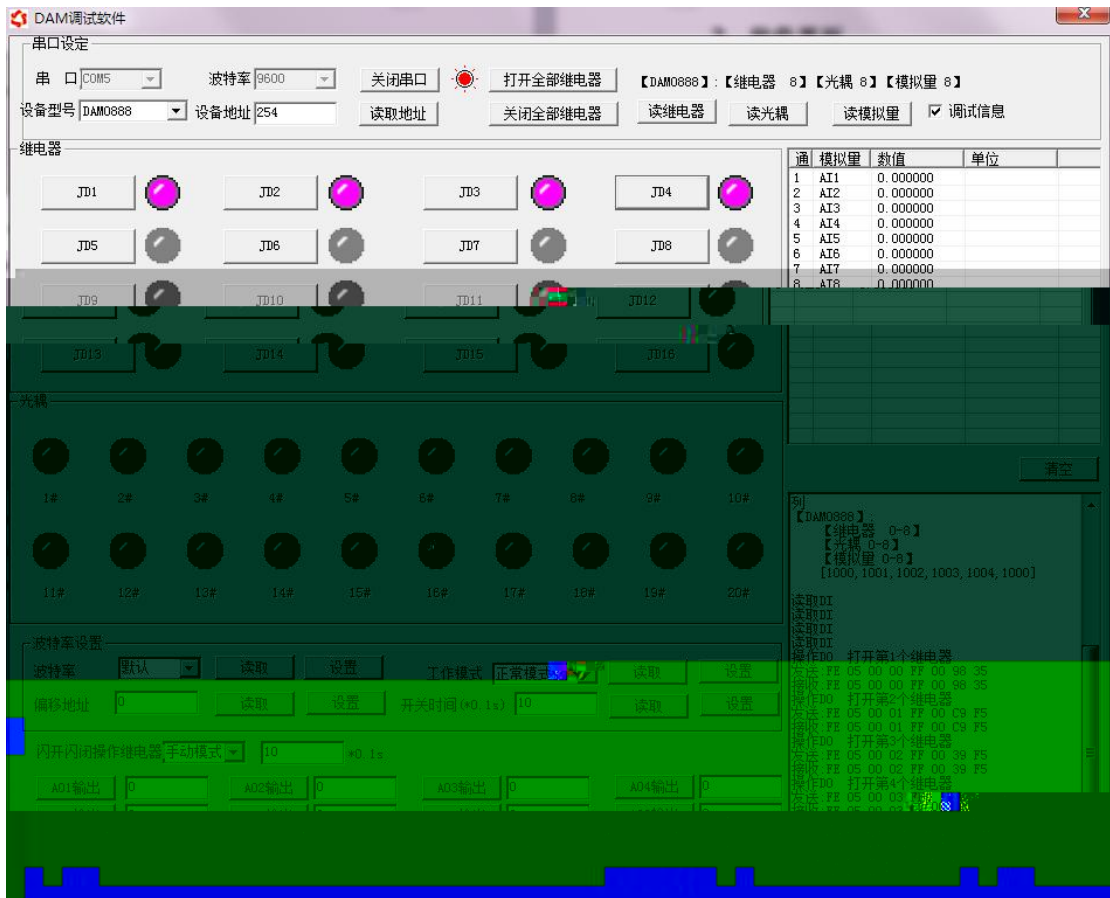
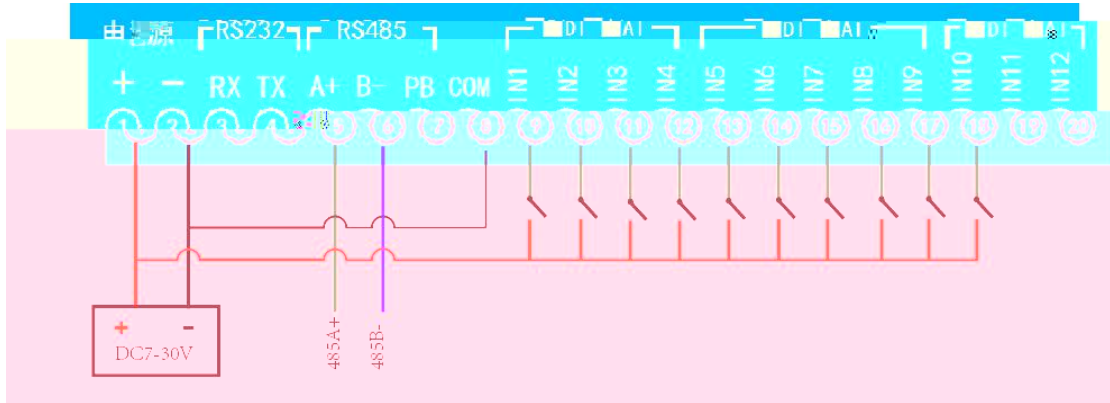



- ①
- ②
- ③



1.1

= +

1.



“ ” “ ”



3.1

3.1.1

—

3.1.2

—
—

3.1.3

—
—

3.1.4

—
—

3.1.5

—
—
" "

3.2



4.1

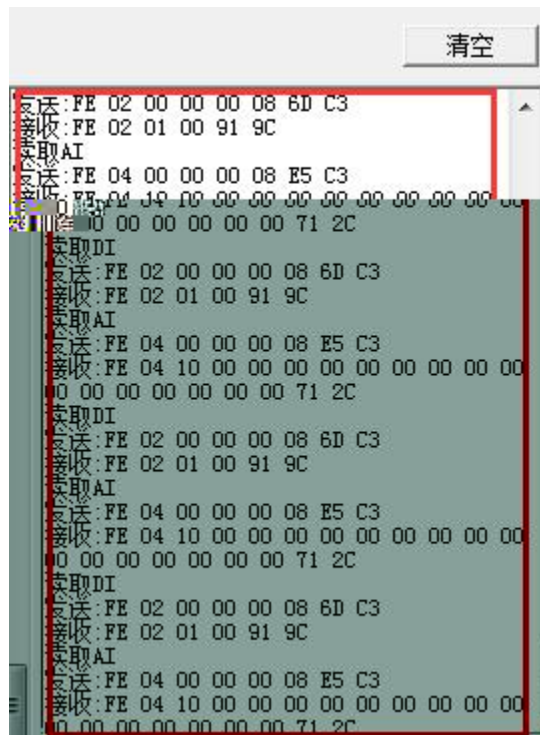
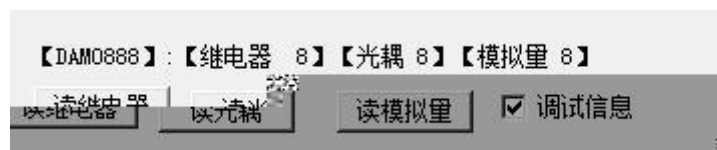

5.2

10

5.3

5.4

FE 10 00 03 00 02 04 00 04 00 0A 00 D8
FE 10 00 03 00 02 04 00 02 00 14 21 62

FE 10 00 03 00 02 A5 C7

5.5

FE 0F 00 00 00 0A 02 FF FF A1 7C
FE 0F 00 00 00 0A 02 00 00 A0 CC

	OF	
00 00		
AO CC		

FE OF 00 00 00 0A C1 C3
FE OF 00 00 00 0A C1 C3

	OF	
00 00		

5.6

1 232

2

3 485

254

JYDAM

<https://www.juyingelectronics.com.cn/software/software/JYDAM%E8%B0%B3%E8%AF%95%E8%BD%AF%E4%BB%B6.rar>

<https://www.juyingelectronics.com.cn/software/jynet/%E4%BB%A5%E5%A4%AA%E7%BD%91%E9%85%8D%E7%BD%AE%E8%BD%AF%E4%BB%B6.rar>

()



JYDAM

