



COM+ D0_1 D0_2 D0_3 D0_4 D0_5 D0_6 D0_7 D0_8 COM-

JY-DAM

DAM0808D-YD

● POWER/DATA

供电电压	DC 7-30V
输入	8路光隔离开关量
输出	8路NPN三极管
通讯接口	<input type="checkbox"/> RS232 <input type="checkbox"/> RS485

01 02 03 04 05 06 07 08

D D D D D D D D C 4 4 G V

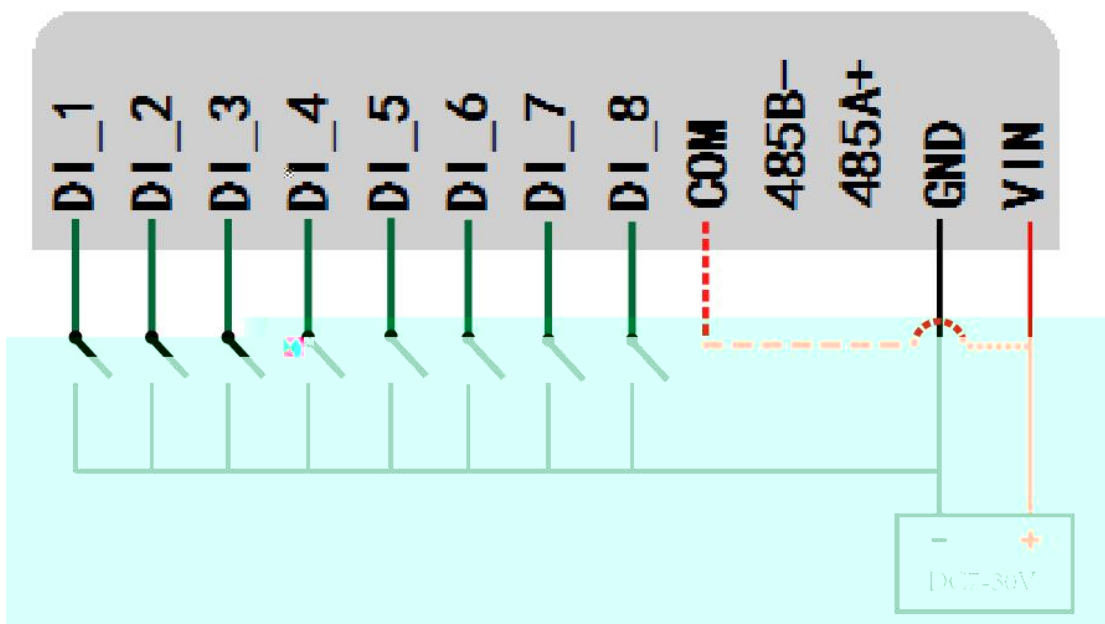
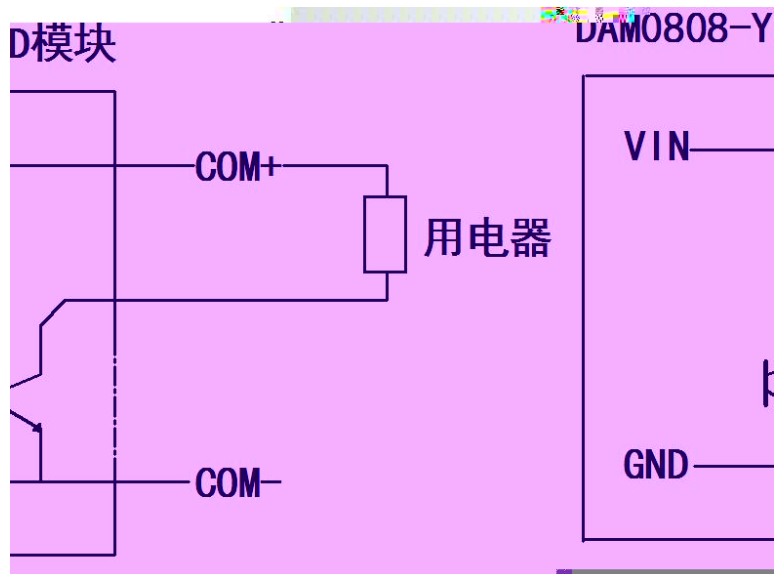

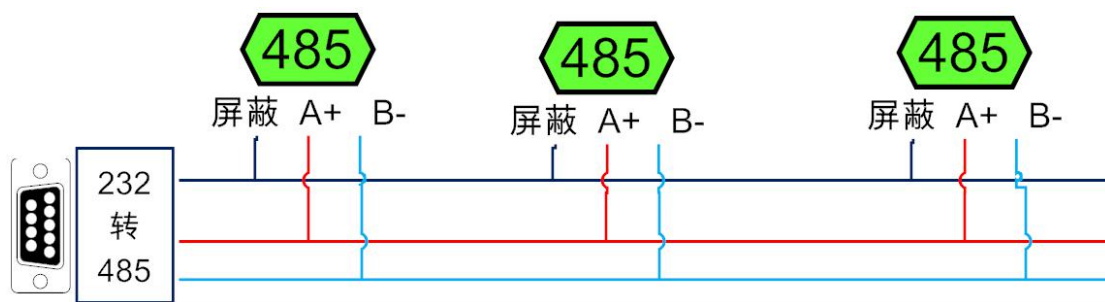
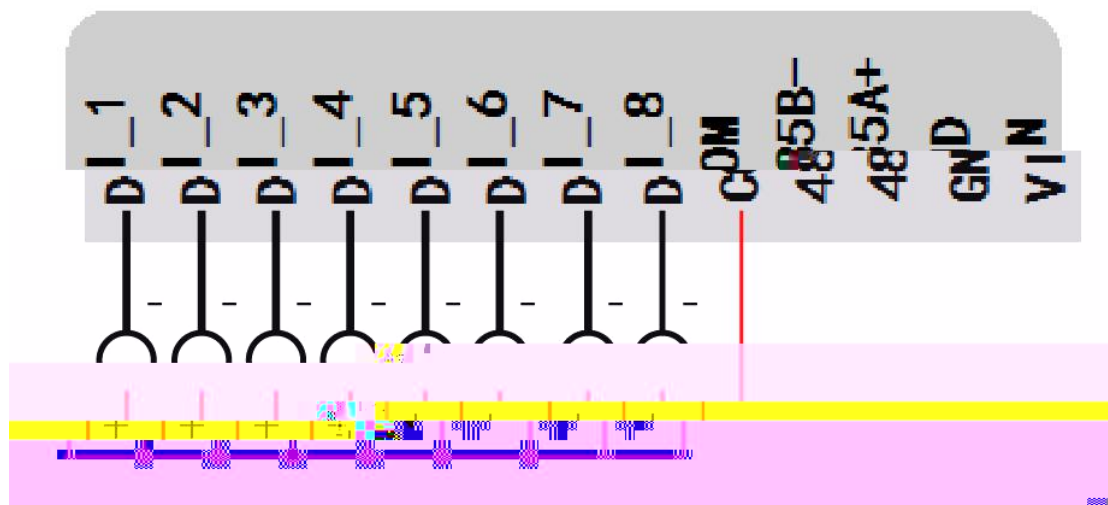



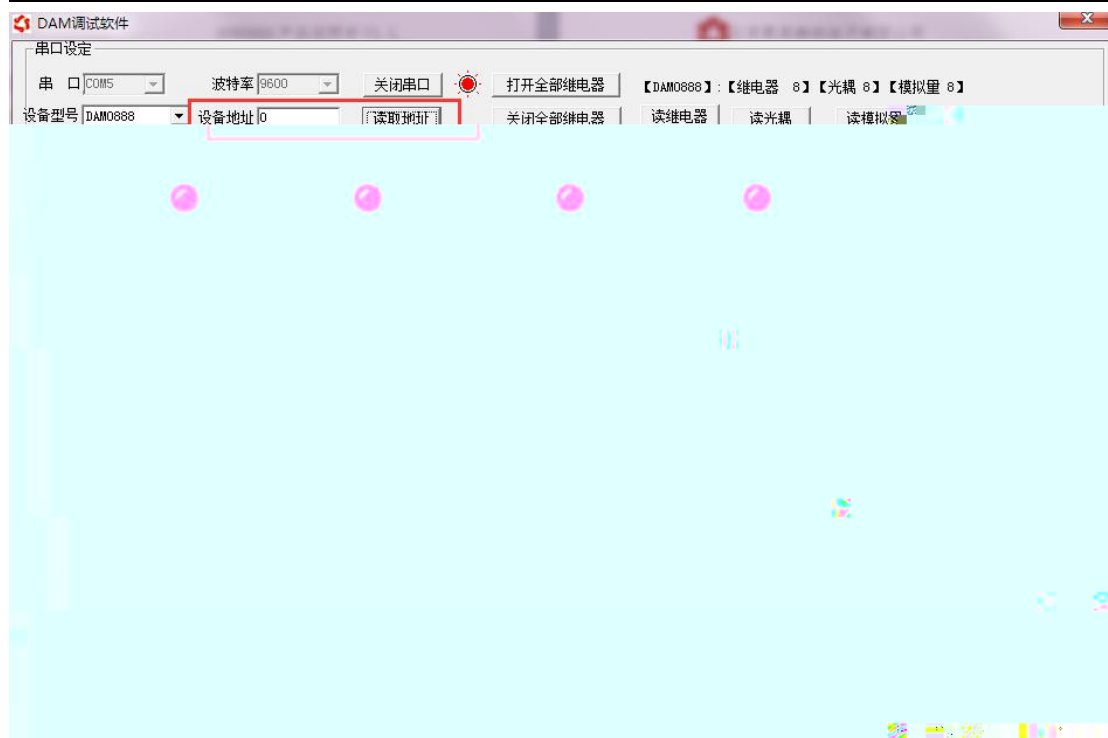

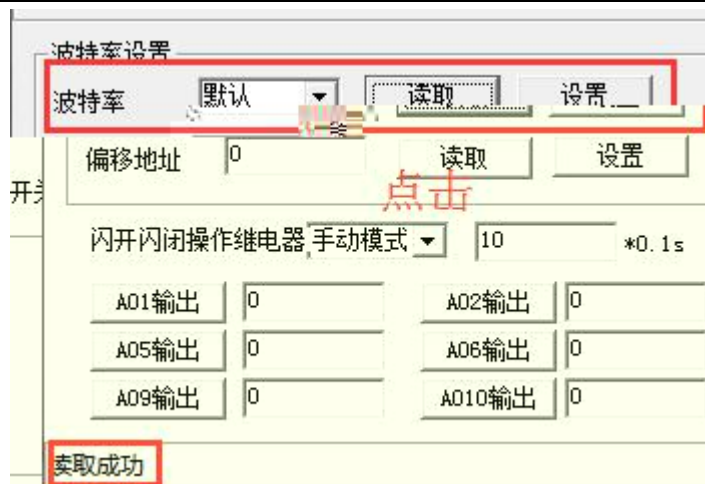

2.1.1

2.1.2

2.1.3

2.1.4

2.1.5



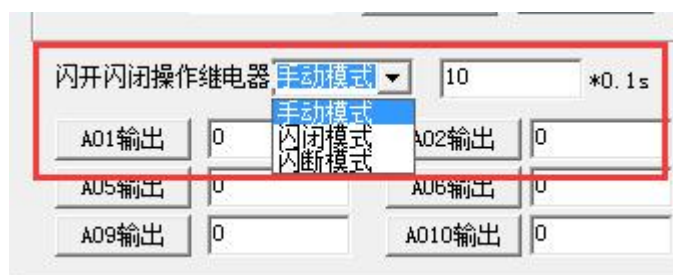

<http://www.juyingele.com.cn/software/software/Modbus%20POLL>

.rar

modbus采集控制卡软件V0300_20150101

串口设定

串口 COM7 波特率 9600 关闭串口 关闭串口 打开全部
 设备型号 DAM0404A 设备地址 254 读取地址 关闭全部 读继电器 读光耦 读模拟量 调试信息

继电器

通	模拟量	数值	单位
1	AI1	0.000000	
2	AI2	0.000000	
3	AI3	0.000000	
4	AI4	0.000000	
5	AI5	0.000000	
6	AI6	0.000000	
7	AI7	0.000000	
8	AI8	0.000000	
9	AI9	0.000000	
10	AI10	0.000000	

